

HALF ROUND GUTTER

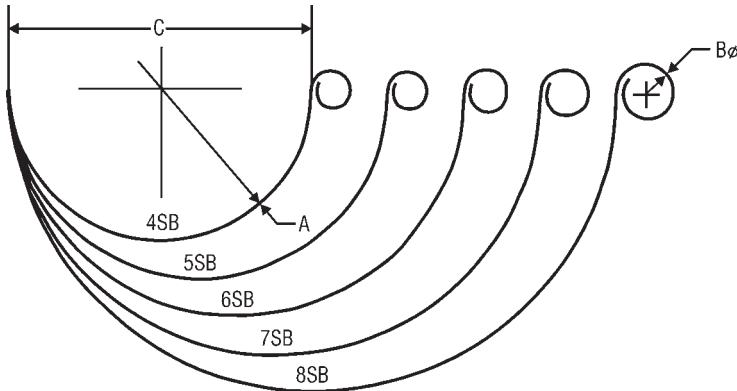

Dimensions for Standard Gutter Sizes

SIZE	LOC.	A	B	C	Girth
4SB		2"	1/2"	4"	8 1/2"
5SB		2 1/2"	1/2"	5"	10"
6SB		3"	9/16"	6"	11 1/2"
7SB		3 1/2"	5/8"	7"	13 1/8"
8SB		4"	5/8"	8"	15"

• AVAILABLE LENGTHS

SIZE	LENGTH	ALUMINUM			COPPER			GALV. STEEL		P-GRIP
		Painted Aluminum 0.027	Painted Aluminum 0.032	Mill Finished	16 ounce	20 ounce	FreedomGray®	24 gauge	26 gauge	Paintgrip 26 gauge
4"SB	10'	N/A	N/A	N/A	•	N/A	N/A	N/A	•	N/A
	20'	N/A	N/A	N/A	•	N/A	N/A	N/A	•	N/A
5"SB	10'	•	•	• .024	•	•	•	•	•	•
	20'	•	•	• .024	•	•	•	•	•	•
	25'	•	•	• .024	•	•	N/A	•	•	•
	30'	•	•	• .024	•	•	•	•	•	•
6"SB	10'	N/A	•	• .032	•	•	•	•	•	•
	20'	N/A	•	• .032	•	•	•	•	•	•
	25'	N/A	•	• .032	•	•	N/A	•	•	•
	30'	N/A	•	• .032	•	•	•	•	•	•
7"SB	10'	N/A	•	•	•	•	N/A	•	•	•
8"SB	10'	N/A	•	•	•	•	N/A	•	•	•

.027 and .032 PAINTED ALUMINUM COLORS AVAILABLE: ▶ High Gloss White ▶ Royal Brown
20 Oz. Copper 7"SB and 8"SB are Available with Extended Lead Times. Manufactured Without Break Lines.

DOUBLE BEAD HALF ROUND GUTTER

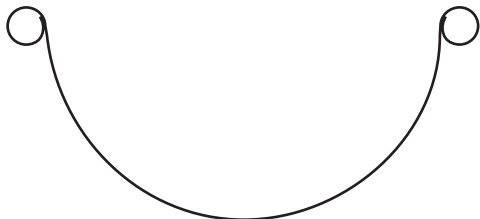

This Gutter Requires Berger Regal Double Bead Bar Hanger
Listed on Page 39

SIZE	LENGTH	COPPER	GALV. STEEL	P-GRIP
		16 ounce	26 gauge	26 gauge
5" DB	10'	•	•	•
6" DB	10'	•	•	•
5" DB	20'	•	•	•
6" DB	20'	•	•	•

PACKAGING FOR HALF ROUND GUTTER: ALUMINUM: 10' to 26' = 10 pcs. per ctn. 27'+ = 5 pcs. per ctn.
COPPER: 5"HR: 10' to 25' = 5 pcs. per ctn. 5"HR: 26'+ = 4 pcs. per ctn. 6"HR: 10' to 21' = 5 pcs. per ctn. 6"HR: 22'+ = 4 pcs. per ctn.



HALF ROUND GUTTER

SINGLE BEAD HALF ROUND GUTTER WITH 1" FLANGE

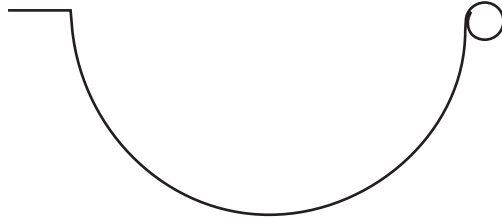

SIZE	LENGTH	COPPER	GALV. STEEL	P-GRIP
		16 ounce	26 gauge	26 gauge
5" SB w/1" FL	10'	•	•	•
5" SB w/1" FL	20'	•	•	•

This Gutter Requires Berger Regal Single Bead Flange Gutter Roof Strap Hanger Listed on Page 40.

PACKAGING: COPPER: 5 pcs. per ctn.

REVERSE BEAD HALF ROUND GUTTER

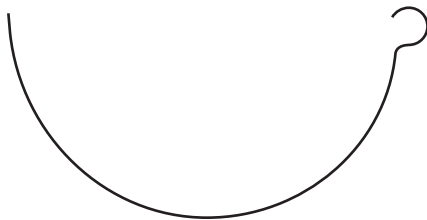

SIZE	LENGTH	ALUMINUM	COPPER	
		Painted	16 ounce	FreedomGray® Copper
6" RB	10'	•	•	•
6" RB	20'	•	•	•

This Gutter Requires Berger Hidden Hanger for Reverse Bead Gutter Listed on Page 39.
*Call for Color Options, Availability and Lead Times on Painted Aluminum Reverse Bead Gutter.
 Some Colors May Require a Minimum Quantity and/or Extended Lead Time.*

PACKAGING: COPPER: 5 pcs. per ctn.

Copper or FreedomGray® Copper Should be Used in Marine and Coastal Areas.
 Galvanized Steel will Rust After Prolonged Exposure in these Environments.



ROUND DOWNSPOUTS

DOWNSPOUTS

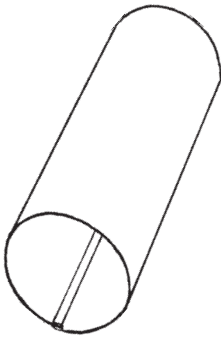

Plain Round Downspout -

3" & 4" Alum. - 100'/ctn. 3", 4" & 5" Copper - 50'/ctn. Galv. Steel - No Box
 5" & 6" MF Alum. - 50'/ctn. 6" Copper - 30'/ctn.

ALUMINUM:

- Standard 3" (.019" thickness) and Standard 4" (.024" thickness) Aluminum is Available in Mill Finished and also in High Gloss White (HG), Royal Brown (BR) and Dark Bronze (DB).
- Standard 5" & 6" (.024" thickness) is Available in Mill Finished Only.

COPPER:

- 3", 4", 5" & 6" Available in 16 Ounce. 3", 4", 5" Also Available in 20 Ounce.

GALVANIZED STEEL:

- 2" Galvanized Steel is Available in 26 Gauge Only.
- 3" & 4" Galvanized Steel is Available in 24 Gauge (24), 26 Gauge (26), 28 Gauge (28) and 30 Gauge (SG).
- 5" & 6" Galvanized Steel is Available in 24 Gauge (24) and 26 Gauge (26).

PAINTGRIP:

- 3", 4", 5" & 6" Paintgrip is Available in 26 Gauge Only.

ENTER COLOR/GAUGE CODE WHEN ORDERING

Metal:	Painted Aluminum		Mill Finished Alum.		16 Oz. Copper		FreedomGray® Copper		Galvanized Steel		Paintgrip	
Size	Code	Price	Code	Price	Code	Price	Code	Price	Code	Price	Code	Price
2"	N/A		N/A		PRPCP2		N/A		PRP262		N/A	
3"	PRP__3		PRPMF3		PRPCP3		PRPFG3		PRP__3		PRPPG3	
4"	PRP__4		PRPMF4		PRPCP4		PRPFG4		PRP__4		PRPPG4	
5"	N/A		PRPMF5		PRPCP5		N/A		PRP__5		PRPPG5	
6"	N/A		PRPMF6		PRPCP6		N/A		PRP__6		PRPPG6	

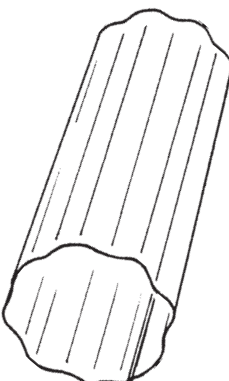

Round Corrugated Downspout -

3" & 4" Alum. - 100'/ctn. 3", 4" & 5" Copper - 50'/ctn. Galv. Steel - No Box
 5" & 6" MF Alum. - 50'/ctn. 6" Copper - 30'/ctn.

ALUMINUM:

- Standard 3" (.019" thickness) and Standard 4" (.024" thickness) Aluminum is Available in Mill Finished and also in High Gloss White (HG), Royal Brown (BR) and Dark Bronze (DB).
- Standard 5" & 6" (.024" thickness) is Available in Mill Finished Only.

COPPER:

- 3", 4", 5" & 6" Available in 16 Ounce. 3", 4", 5" Also Available in 20 Ounce.

GALVANIZED STEEL:

- 2" Galvanized Steel is Available in 26 Gauge Only.
- 3" & 4" Galvanized Steel is Available in 24 Gauge (24), 26 Gauge (26), 28 Gauge (28) and 30 Gauge (SG).
- 5" & 6" Galvanized Steel is Available in 24 Gauge (24) and 26 Gauge (26).

PAINTGRIP:

- 3", 4", 5" & 6" Paintgrip is Available in 26 Gauge Only.

ENTER COLOR/GAUGE CODE WHEN ORDERING

Metal:	Painted Aluminum		Mill Finished Alum.		16 Oz. Copper		FreedomGray® Copper		Galvanized Steel		Paintgrip	
Size	Code	Price	Code	Price	Code	Price	Code	Price	Code	Price	Code	Price
2"	N/A		N/A		N/A		N/A		RCP262		N/A	
3"	RCP__3		RCPMF3		RCPCP3		RCPFG3		RCP__3		RCPG3	
4"	RCP__4		RCPMF4		RCPCP4		RCPFG4		RCP__4		RCPG4	
5"	N/A		RCPMF5		RCPCP5		N/A		RCP__5		RCPG5	
6"	N/A		RCPMF6		RCPCP6		N/A		RCP__6		RCPG6	

RAIN CHAINS

DOWNSPOUTS

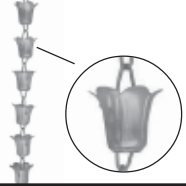
	"Tulip" Rain Chain - 1 pc. per ctn., 8 1/2' Length	
	Copper	
	Code	Price
	255305	

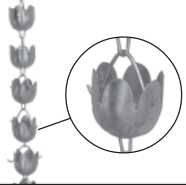
	"SunDrop" Rain Chain - 1 pc. per ctn., 8 1/2' Length	
	Copper	
	Code	Price
	255032	

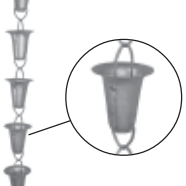
	"Funnel" Rain Chain - 1 pc. per ctn., 8 1/2' Length	
	Copper	
	Code	Price
	255020	

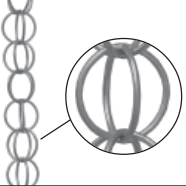
	"Link Ring" Rain Chain - 1 pc. per ctn., 8 1/2' Length	
	Copper	
	Code	Price
	235805	

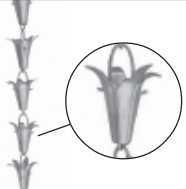
	"Lily" Rain Chain - 1 pc. per ctn., 8 1/2' Length	
	Copper	
	Code	Price
	265005	

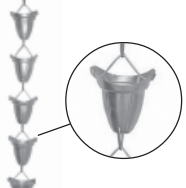
	"Bell Cup" Rain Chain - 1 pc. per ctn., 8 1/2' Length	
	Copper	
	Code	Price
	255052	



ROUND ELBOWS

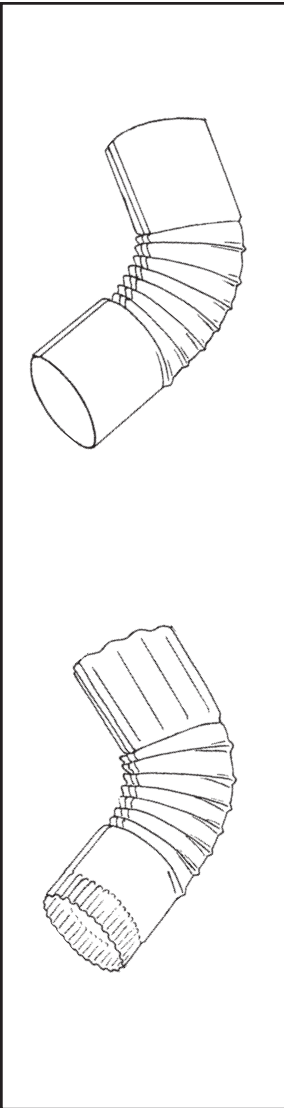

Plain Round and Round Corrugated Elbows -
 3" & 4" Alum. - 30 pcs./ctn. 3" & 4" Galv. - 20 pcs./ctn.
 5" & 6" Alum. & Galv. - 10 pcs./ctn. Copper Elbows - 10 pcs./ctn. All 2" - 20 pcs./ctn.

- Elbow Angles Available in 90 Degrees (4), **STANDARD 75 Degrees (3)**, 60 Degrees (2), 45 Degrees (1) and 30 Degrees (0).
- Elbow Angles Specified other than the Standard 75 Degrees (3) are Considered a Special Order and may Require an Extended Lead Time. Special Orders are Not Subject to Cancellation or Return.
- 3" & 4" Aluminum Elbows are Available in High Gloss White (HG), Royal Brown (BR), Dark Bronze (DB) and Mill Finished (MF).
- 5" & 6" Aluminum Elbows are Available in Mill Finished Only.
- 3" Aluminum Elbows are .019 Standard Gauge.
- 4", 5" & 6" Aluminum Elbows are .024 Standard Gauge.
- ***All Lap Joined Elbows Must be Soldered or Sealed Prior to Installation.**

ENTER COLOR/METAL/ANGLE CODE WHEN ORDERING

Metal:	Aluminum		16 Oz. Copper		FreedomGray® Copper		26 Gauge Galvanized Steel		Paintgrip	
Size	Code	Price	Code	Price	Code	Price	Code	Price	Code	Price
PLAIN ROUND										
2"	N/A		PR3CP2		N/A		PR63P2		N/A	
3"	PR3__3		PR3CP3		PR3FG3		PR63P3		PR63G3	
4"	PR3__4		PR3CP4		PR3FG4		PR63P4		PR63G4	
5"	PR3MF5		PR3CP5		N/A		PR63P5		PR63G5	
6"	PR3MF6		PR3CP6		N/A		PR63P6		PR63G6	
ROUND CORRUGATED										
2"	N/A		RC3CP2		N/A		RC63P2		N/A	
3"	RC3__3		RC3CP3		RC3FG3		RC63P3		RC63G3	
4"	RC3__4		RC3CP4		RC3FG3		RC63P4		RC63G4	
5"	RC3MF5		RC3CP5		N/A		RC63P5		RC63G5	
6"	RC3MF6		RC3CP6		N/A		RC63P6		RC63G6	

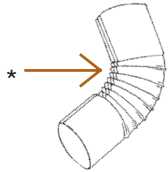

*Flat Seam Distortion Can Occur Due to Stretching of Diameter when Forming. This Can Permit Capillary Action to Cause Drips from Seam when Used in Lower Position with Water Flow on Seam. This may Require Sealant or Solder to Prevent Drip.

GUTTER ACCESSORIES



ROUND & SQUARE OFFSETS

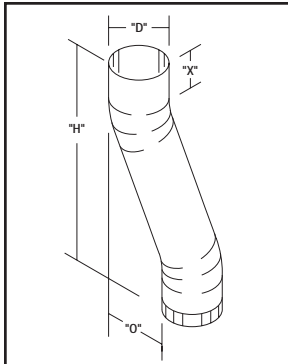

Plain Round Offsets - 10 pcs. per ctn

- .019 Aluminum Offsets are Available in White (WA) Only.
- Copper (CP) is Available in 16 Oz. Only.
- Galvanized Steel (GS) is Available in 26 Gauge Only.

ENTER COLOR/METAL CODE WHEN ORDERING

Pipe Size	Offset "O"	Diameter "D"	"X"	Height "H"	Code	Price	
3" PR	2"	3"	2.5"	9.2"	OFPR3__15		
3" PR	3"	3"	2.5"	12.0"	OFPR3__3		
3" PR	4"	3"	2.5"	13.5"	OFPR3__4		
3" PR	5"	3"	2.5"	14.5"	OFPR3__5		
4" PR	2"	4"	3"	11.4"	OFPR4__15		
4" PR	3"	4"	3"	14.1"	OFPR4__3		
4" PR	4"	4"	3"	15.9"	OFPR4__4		
4" PR	5"	4"	3"	17.7"	OFPR4__5		

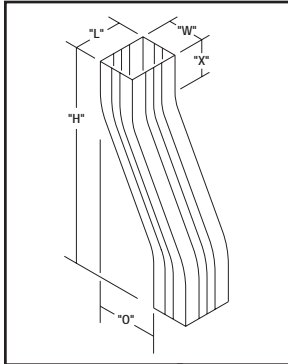

Square Corrugated Offsets - 10 pcs. per ctn

- .019 Aluminum Offsets are Available in White (WA) Only.
- Copper (CP) is Available in 16 Oz. Only.
- Galvanized Steel (GS) is Available in 26 Gauge Only.

ENTER COLOR/METAL CODE WHEN ORDERING

Pipe Size	Offset "O"	Length "L"	Width "W"	"X"	Height "H"	Code	Price
2" x 3" Sq. Corr.	2"	3"	2"	2.5"	9.2"	OFSC3__15	
2" x 3" Sq. Corr.	3"	3"	2"	2.5"	12.0"	OFSC3__3	
2" x 3" Sq. Corr.	4"	3"	2"	2.5"	13.5"	OFSC3__4	
2" x 3" Sq. Corr.	5"	3"	2"	2.5"	14.5"	OFSC3__5	
3" x 4" Sq. Corr.	2"	4"	3"	3"	11.4"	OFSC4__15	
3" x 4" Sq. Corr.	3"	4"	3"	3"	14.1"	OFSC4__3	
3" x 4" Sq. Corr.	4"	4"	3"	3"	15.9"	OFSC4__4	
3" x 4" Sq. Corr.	5"	4"	3"	3"	17.7"	OFSC4__5	

GUTTER ACCESSORIES

HALF ROUND HANGERS

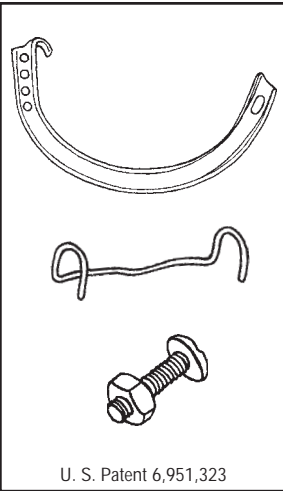

Gem Circle with Spring Clip, Nut & Bolt - 50 pcs. per ctn.

- 5" & 6" Aluminum Available in High Gloss White (HG), Royal Brown (BA) and Mill Finished (MF).
- 5" & 6" Painted Galvanized Steel Available in White (WS) and Royal Brown (BS).
- FreedomGray® Copper – This accessory item is not formed from FreedomGray® coil or sheet product. It is formed from copper product that is then plated with a Tin Zinc coating to provide similar color and properties. FreedomGray® is a registered trademark of Revere Copper Products, Inc.

ENTER COLOR CODE WHEN ORDERING

Metal:	Aluminum		Copper		FreedomGray® Copper		Galvanized Steel		Painted Galv. Steel	
Size	Code	Price	Code	Price	Code	Price	Code	Price		
4"	N/A		CIRCP4		N/A		CIRCS4		N/A	
5"	CIR__5		CIRCP5		CIRFG5		CIRCS5		CIR__5	
6"	CIR__6		CIRCP6		CIRFG5		CIRCS6		CIR__6	

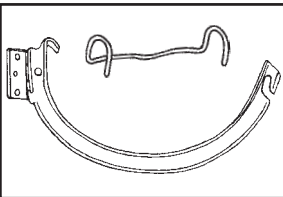

#10 Combination Circle & Shank with Spring Clip - 50 pcs. per ctn.

Metal:	Copper		Galvanized Steel	
Size	Code	Price	Code	Price
4"	CCC104		CCS104	

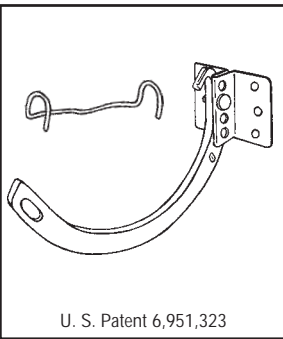

#10 Combination Circle & Shank with Spring Clip - 50 pcs. per ctn.

- 5" & 6" Painted Aluminum Available in High Gloss White (CHG) and Royal Brown (CBA).
- ENTER COLOR CODE WHEN ORDERING**

Metal:	Mill Finished Aluminum		Painted Aluminum		Copper		Galvanized Steel	
Size	Code	Price	Code	Price	Code	Price	Code	Price
5"	CCA105		CB__5		CCC105		CCS105	
6"	CCA106		CB__6		CCC106		CCS106	

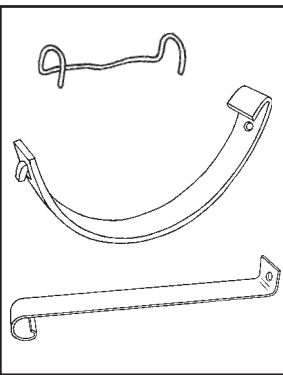

Face Mount Hanger with Crossbar and Spring Clip - 50 pcs. per ctn.

- Hanger is Made from 3/16" x 1" Bar Stock and Come with a 1/16" x 1" Crossbar Used for Added Strength.
- 7" & 8" Galvanized Steel and Paintgrip are Considered a Special Order and may Require Extended Lead Time of at Least 3 Weeks. Special Orders are Not Subject to Cancellation or Return.
- Hanger Spacing for 7" & 8" Gutter Should Not Exceed 24" O.C.

Metal:	Mill Finished Aluminum		Copper		Galvanized Steel		Paintgrip	
Size	Code	Price	Code	Price	Code	Price	Code	Price
7"	HRFMF7		HRFCP7		HRFGL7		N/A	
8"	HRFMF8		HRFCP8		HRFGL8		HRFPG8	

Copper or FreedomGray® Copper Should be Used in Marine and Coastal Areas. Galvanized Steel will Rust After Prolonged Exposure in these Environments.

GUTTER ACCESSORIES



HALF ROUND HANGERS

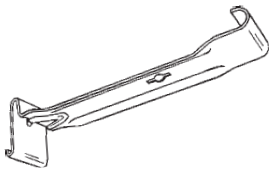

Hidden Hanger for Reverse Bead Gutter Only - 100 pcs. per ctn.

- Aluminum Available in Mill Finished Only.

Metal:	Mill Finished Aluminum		Copper		Stainless Steel	
Size	Code	Price	Code	Price	Code	Price
6"	HIDHA6		HIDHC6		45677	

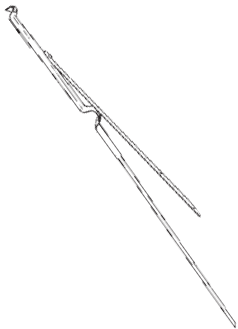

Rival Strap Hanger - 50 pcs. per ctn.

- 5" & 6" Aluminum Available in High Gloss White (HG), Royal Brown (BA) and Mill Finished (MF).
- Maximum Spacing for Snow Areas, Wind Areas and Severe Weather Climates is 16" O.C.

ENTER COLOR CODE WHEN ORDERING

Metal:	Aluminum		Copper		Galvanized Steel	
Size	Code	Price	Code	Price	Code	Price
4"	N/A		RIVCP4		RIVGL4	
5"	RIV__5		RIVCP5		RIVGL5	
6"	RIV__6		RIVCP6		RIVGL6	

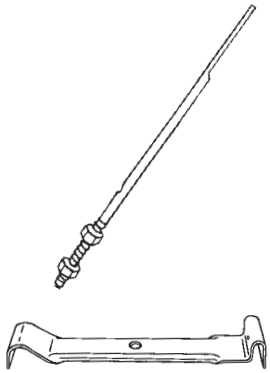

Regal Bar Hanger - 50 pcs. per ctn.

- Hanger Includes Rod & Nut Assembly.
- Improved Version of Imperial Bar Hanger.
- Hanger Requires Final Form to Bead by Installer.
- Hanger Spacing for 7" & 8" Gutter Should Not Exceed 24" O.C.

Metal:	Mill Finished Aluminum		Copper		Galvanized Steel	
Size	Code	Price	Code	Price	Code	Price
5"	REGMF5		REGCP5		REGGL5	
6"	REGMF6		REGCP6		REGGL6	
7"	REGMF7		REGCP7		REGGL7	
8"	REGMF8		REGCP8		REGGL8	

U. S. Patent D481,929

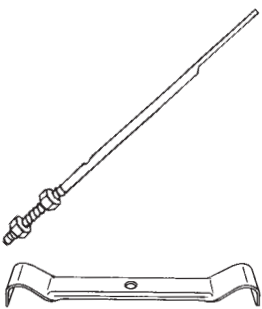

Regal Double Bead Bar Hanger - 50 pcs. per ctn.

- Hanger Includes Rod & Nut Assembly.
- Improved Version of Double Bead Hanger.
- Hanger Requires Final Form to Bead by Installer.

Metal:	Copper		Galvanized Steel	
Size	Code	Price	Code	Price
5"	REGDC5		REGDG5	
6"	REGDC6		REGDG6	

U. S. Patent D481,929

Copper or FreedomGray® Copper Should be Used in Marine and Coastal Areas. Galvanized Steel will Rust After Prolonged Exposure in these Environments.

GUTTER ACCESSORIES

HALF ROUND HANGERS

GUTTER ACCESSORIES

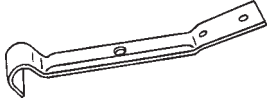

Regal Single Bead Flange Gutter Roof Strap Hanger - 50 pcs. per ctn.

- Crossbar Nail Type Hanger.

Metal:	Copper		Galvanized Steel	
Size	Code	Price	Code	Price
5"	REGFC5		REGFG5	
6"	REGFC6		REGFG6	

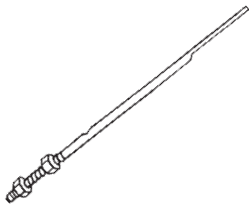

Rod & Nuts for Regal Bar Hanger - 100 pcs. per ctn.

- Brass is used with Copper Hanger.

Metal:	Mill Finished Aluminum		Brass	
Size	Code	Price	Code	Price
One Size	RODNUT		RNBRAS	



Spring Clip for Gem Circle / #10 Combination Hanger - 50 pcs. per bag

- Painted Aluminum Available in High Gloss White (WA) and Royal Brown (BA).
- Use Stainless Steel Spring Clip for FreedomGray® Copper.

ENTER COLOR CODE WHEN ORDERING

Metal:	Painted Aluminum		Brass		Galvanized Steel		Stainless Steel	
Size	Code	Price	Code	Price	Code	Price	Code	Price
One Size	SPCL___		SPCLBR		SPCLGL		SPCLFG	



Nut & Bolt for Shanks - 50 pcs. per ctn.

- #10 - 24 Thread x 3/4" Long.

Metal:	Brass		Galvanized Steel	
Size	Code	Price	Code	Price
One Size	BN-CP		BN-S	

Copper or FreedomGray® Copper Should be Used in Marine and Coastal Areas. Galvanized Steel will Rust After Prolonged Exposure in these Environments.



“K” STYLE & HALF ROUND SHANKS

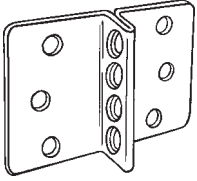

U. S. Patent 6,951,323

#1 Shank Plate for Fascia - 50 pcs. per ctn.

- Aluminum Available in High Gloss White (HG), Royal Brown (BA) and Mill Finished (MF).
- FreedomGray® Copper – This accessory item is not formed from FreedomGray® coil or sheet product. It is formed from copper product that is then plated with a Tin Zinc coating to provide similar color and properties. FreedomGray® is a registered trademark of Revere Copper Products, Inc.

ENTER COLOR CODE WHEN ORDERING

Aluminum		Copper		FreedomGray® Copper		Galvanized Steel	
Code	Price	Code	Price	Code	Price	Code	Price
SH__-1		SHCP-1		SHFG-1		SHCS-1	



#6 Shank for Ogee or Crown Molding - 50 pcs. per ctn.

- Painted Galvanized Steel is Available in White (WS) and Royal Brown (BS).

ENTER COLOR CODE WHEN ORDERING

Copper		Galvanized Steel		Painted Galvanized Steel	
Code	Price	Code	Price	Code	Price
SHCP-6		SHCS-6		SH__-6	



#8 Shank for Cornice - 50 pcs. per ctn.

Malleable Iron	
Code	Price
SH-CM8	

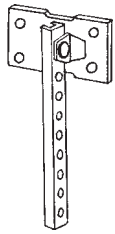

#10 Shank for Fascia - 50 pcs. per ctn.

- Painted Galvanized Steel Available in White (W) and Brown (B).

ENTER COLOR CODE WHEN ORDERING

Copper		Galvanized Steel		Painted Galvanized Steel	
Code	Price	Code	Price	Code	Price
SHCP10		SHCS10		SHWS10	

Note: Galvanized and Painted Steel Shanks are NOT Recommended for Coastal Salt Air Environment Due to Corrosion Potential. Copper Should be Used.

GUTTER ACCESSORIES

“K” STYLE & HALF ROUND SHANKS



#11 Shank for Nailing to Exposed Rafter - 50 pcs. per ctn.

- Painted Aluminum Available in High Gloss White (HG) and Royal Brown (BA).

ENTER COLOR CODE WHEN ORDERING

Painted Aluminum		Copper		Galvanized Steel	
Code	Price	Code	Price	Code	Price
SH__11		SHCP11		SHCS11	

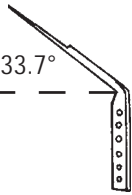

#12 Shank for Nailing to Sheeting - 1/3 Pitch - 50 pcs. per ctn.

33.7°

- Aluminum Available in High Gloss White (HG), Royal Brown (BA) and Mill Finished (MF).
- Painted Galvanized Steel is Available in White (WS) and Royal Brown (BS).
- FreedomGray® Copper – This accessory item is not formed from FreedomGray® coil or sheet product. It is formed from copper product that is then plated with a Tin Zinc coating to provide similar color and properties. FreedomGray® is a registered trademark of Revere Copper Products, Inc.

ENTER COLOR CODE WHEN ORDERING

Aluminum		Copper		FreedomGray® Copper		Galvanized Steel		Painted Galvanized Steel	
Code	Price	Code	Price	Code	Price	Code	Price	Code	Price
SH__12		SHCP12		SHFG12		SHCS12		SH__12	

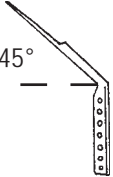

#25 Shank for Nailing to Sheeting - 1/2 Pitch - 50 pcs. per ctn.

45°

Copper		Galvanized Steel	
Code	Price	Code	Price
SHCP25		SHCS25	



#30 Shank for Adjustable Pitch Rafters & Fascia - 50 pcs. per ctn.

- Painted Aluminum Available in High Gloss White (HG) and Royal Brown (BA).
- FreedomGray® Copper – This accessory item is not formed from FreedomGray® coil or sheet product. It is formed from copper product that is then plated with a Tin Zinc coating to provide similar color and properties. FreedomGray® is a registered trademark of Revere Copper Products, Inc.

ENTER COLOR CODE WHEN ORDERING

Painted Aluminum		Copper		FreedomGray® Copper		Galvanized Steel	
Code	Price	Code	Price	Code	Price	Code	Price
SH__30		SHCP30		SHFG30		SHCS30	

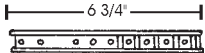

Shank Extension - 50 pcs. per ctn.

6 3/4"

- Aluminum Available in High Gloss White (HG) and Royal Brown (BA).

ENTER COLOR CODE WHEN ORDERING

Painted Aluminum		Copper		Galvanized Steel	
Code	Price	Code	Price	Code	Price
SH__EX		SHCPEX		SHCSEX	

Note: Galvanized and Painted Steel Shanks are NOT Recommended for Coastal Salt Air Environment Due to Corrosion Potential. Copper Should be Used.

GUTTER ACCESSORIES



"K" STYLE & HALF ROUND END CAPS



K-Style End Cap - LEFT and RIGHT - 50 pcs. per ctn.

- 5" & 6" Aluminum are Available in Mill Finished and 21 Standard Colors (*Call for Codes*):
 - 30° White Low Gloss • 80° White High Gloss • Antique Ivory • Almond • Beaver Brown • Buckskin Brown
 - Terratone Bronze • CB Gray • Clay • Cream • Dark Bronze • Grecian Green • Herringbone • Bone Linen
 - Musket Brown • Pearl Gray • Royal Brown • Red • Tuxedo Gray • Wicker.
- 7" & 8" Aluminum Available in High Gloss White (HG) and Dark Bronze (DB).
- Painted Galvanized Steel Available in White (WS) and Royal Brown (BS).

ENTER COLOR CODE WHEN ORDERING

Metal:	Aluminum		Copper (16 Oz.)		Galvanized Steel (26 Ga.)		Painted Gal. Steel		Paintgrip (26 Ga.)	
Size	Code	Price	Code	Price	Code	Price	Code	Price	Code	Price
LEFT										
5"	5ENL__		ENLCP5		ENL265		ENL__5		ENL6G5	
6"	6ENL__		ENLCP6		ENL266		ENL__6		ENL6G6	
7"	ENL__7		ENLCP7		ENL267		N/A		N/A	
8"	ENL__8		ENLCP8		ENL268		N/A		N/A	
RIGHT										
5"	5ENR__		ENRCP5		ENR265		ENR__5		ENR6G5	
6"	6ENR__		ENRCP6		ENR266		ENR__6		ENR6G6	
7"	ENR__7		ENRCP7		ENR267		N/A		N/A	
8"	ENR__8		ENRCP8		ENR268		N/A		N/A	

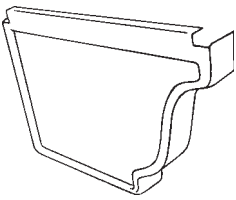

K-Style Rivet Cap - LEFT and RIGHT - 50 pcs. per ctn.

- Painted Aluminum Available in White Only.

Metal:	Aluminum - LEFT		Aluminum - RIGHT	
Size	Code	Price	Code	Price
5"	10140		10141	

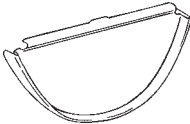

Half Round End Cap "C" Style - 50 pcs. per ctn.

- Aluminum Available in High Gloss White (HG), Royal Brown (BA) and Mill Finished (MF).

ENTER COLOR CODE WHEN ORDERING

Metal:	Aluminum		Copper (16 Oz.)		FreedomGray® Copper		Galvanized Steel (26 Ga.)		Paintgrip (26 gauge)	
Size	Code	Price	Code	Price	Code	Price	Code	Price	Code	Price
4"	N/A		CENCP4		N/A		CEN264		N/A	
5"	CEN__5		CENCP5		CENFG5		CEN265		CEN6G5	
6"	CEN__6		CENCP6		CENFG6		CEN266		CEN6G6	
7"	CEN__7		CENCP7		N/A		CEN267		CEN6G7	
8"	CEN__8		CENCP8		N/A		N/A		CEN6G6	

GUTTER ACCESSORIES



"K" STYLE & HALF ROUND MITERS

	K-Style Bay Strip Miter - INSIDE and OUTSIDE - 20 pcs. per ctn.								
	• 5" & 6" Painted Aluminum Available in White Only.								
	Metal:	Aluminum - INSIDE		Aluminum - OUTSIDE		Copper - INSIDE		Copper - OUTSIDE	
	Size	Code	Price	Code	Price	Code	Price	Code	Price
	5"	5ISMBS80W		50SMBS80W		5ISMBC		50SMBC	
6"	6ISMBS80W		60SMBS80W		6ISMBC		60SMBC		

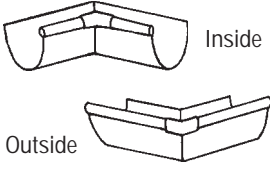
	Half Round 90 Degree Miter - INSIDE and OUTSIDE - 20 pcs. per ctn.									
	<ul style="list-style-type: none"> • 5" Aluminum Available in High Gloss White (HG), Royal Brown (BA) and Mill Finished (MF). • 6", 7" & 8" Painted Aluminum Available in High Gloss White (HG) and Royal Brown (BA). • 7" & 8" Require Extended Lead Time. 									
	ENTER COLOR CODE WHEN ORDERING									
Metal:	Aluminum		Copper (16 Oz.)		FreedomGray® Copper		Galv. Steel (26 Ga.)		Paintgrip (26 Ga.)	
Size	Code	Price	Code	Price	Code	Price	Code	Price	Code	Price
INSIDE										
4"	N/A		LISCP4		N/A		N/A		N/A	
5"	LIS__5		LISCP5		LISFG5		LIS265		LIS6G5	
6"	LIS__6		LISCP6		LISFG6		LIS266		LIS6G6	
7"	LIS__7		LISCP7		N/A		LIS267		N/A	
8"	LIS__8		LISCP8		N/A		LIS268		N/A	
OUTSIDE										
4"	N/A		LOSCP4		N/A		N/A		N/A	
5"	LOS__5		LOSCP5		LOSG5		LOS265		LOS6G5	
6"	LOS__6		LOSCP6		LOSG6		LOS266		LOS6G6	
7"	LOS__7		LOSCP7		N/A		LOS267		N/A	
8"	LOS__8		LOSCP8		N/A		LOS268		N/A	

GUTTER ACCESSORIES

“K” STYLE & HALF ROUND END PIECES / SLIP JOINTS

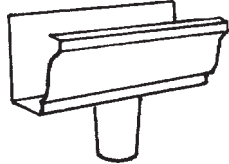

K-Style End Piece - 5" x 3" - 20 pcs. per ctn. *

- Painted Aluminum Available in High Gloss White (HG) and Royal Brown (BR).
- Painted Galvanized Steel is Available in White Only.
- *Galvanized Steel is 12 pcs. per ctn.

ENTER COLOR CODE WHEN ORDERING

Metal:	Painted Aluminum		Copper (16 oz)		Galvanized Steel (26 gauge)	
Size	Code	Price	Code	Price	Code	Price
5" x 3"	KEP__5		KEPCP5		KEP265	

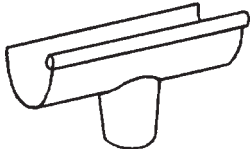

Half Round End Pieces - 20 pcs. per ctn.

- 5" x 3" Painted Aluminum Available in High Gloss White (HG) and Royal Brown (BA).

ENTER COLOR CODE WHEN ORDERING

Metal:	Painted Aluminum		Copper (16 oz)		Galvanized Steel (26 gauge)	
Size	Code	Price	Code	Price	Code	Price
4" x 3"	N/A		N/A		DE2643	
5" x 3"	DEP__5		DECP53		DE2653	
6" x 4"	N/A		N/A		DE2664	

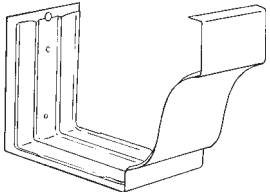

K-Style Slip Joint - 50 pcs. per ctn.

- Painted Aluminum Available in High Gloss White (HG) and Royal Brown (BR).
- Painted Galvanized Steel Available in White Only.
- KSJ265 Available in 30 pieces per carton.

ENTER COLOR CODE WHEN ORDERING

Metal:	Painted Aluminum		Copper (16 oz)		Galvanized Steel (26 gauge)		Painted Gal. Steel	
Size	Code	Price	Code	Price	Code	Price	Code	Price
5"	KSJ__5		KSJCP5		KSJ265		KSJWS5	

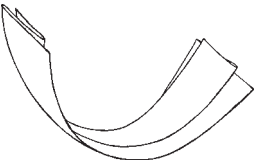

Half Round Slip Joint - 50 pcs. per ctn.

- 5" & 6" Painted Aluminum Available in High Gloss White (HG) and Royal Brown (BA).

ENTER COLOR CODE WHEN ORDERING

Metal:	Painted Aluminum		Copper (16 oz)		Galvanized Steel (26 gauge)	
Size	Code	Price	Code	Price	Code	Price
4"	N/A		SCNCP4		SCN264	
5"	SCN__5		SCNCP5		SCN265	
6"	SCN__6		SCNCP6		SCN266	

"K" STYLE & HALF ROUND OUTLETS



3" & 4"



5" & 6"

Half Round B Style Outlet - 50 pcs. per ctn.

- 3" & 4" Aluminum is Available in High Gloss White (HG), Royal Brown (BA) and Mill Finished (MF).
- 5" & 6" Aluminum is Available in Mill Finished Only.

ENTER COLOR CODE WHEN ORDERING

Metal:	Aluminum		Copper (16 Oz.)		FreedomGray® Copper		Galvanized Steel (26 Ga.)	
Size	Code	Price	Code	Price	Code	Price	Code	Price
3"	RBO__3		RBOCP3		RBOFG3		RBO263	
4"	RBO__4		RBOCP4		RBOFG4		RBO264	
5"	RBOMF5		RBOCP5		N/A		RBO265	
6"	RBOMF6		RBOCP6		N/A		RBO266	



Half Round Wide Flange B Style Outlet - 50 pcs. per ctn.

- 3" & 4" Aluminum is Available in High Gloss White (HG) and Royal Brown (BA).

ENTER COLOR CODE WHEN ORDERING

Metal:	Painted Aluminum	
Size	Code	Price
3"	WBO__3	
4"	WBO__4	



Half Round WB Pop Rivet Style Outlet - 50 pcs. per ctn.

- 3" Aluminum is Available in High Gloss White (HG) and Royal Brown (BA).

ENTER COLOR CODE WHEN ORDERING

Metal:	Painted Aluminum		Copper (16 Oz.)		Galvanized Steel (26 Ga.)	
Size	Code	Price	Code	Price	Code	Price
3"	WBP__3		WBPCP3		WBP263	



Round Snap In Tube Outlet - 250 pcs. per ctn.

Metal:	Mill Finished Aluminum	
Size	Code	Price
2-3/8"	21249	
2-3/4"	21149	

GUTTER ACCESSORIES



"K" STYLE & HALF ROUND CONDUCTOR HEADS

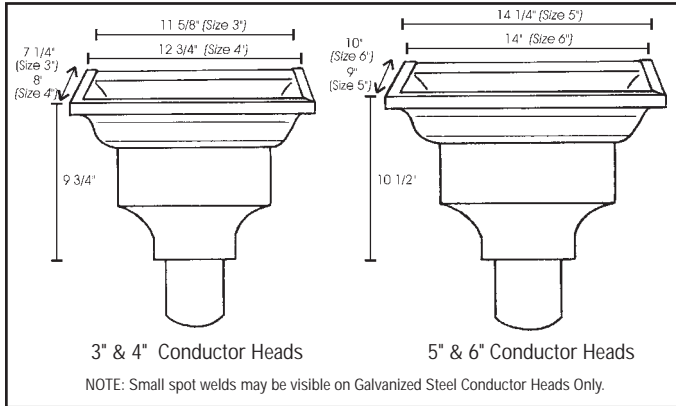

#14 Conductor Head with Oval Outlet - 3", 4" & 5" - 6 pcs. per ctn. 6" - 4 pcs. per ctn.

Metal:	Copper		Galvanized Steel		Paintgrip	
Size	Code	Price	Code	Price		
3"	CHOC3		CHOGL3		N/A	
4"	CHOC4		CHOGL4		CHFG4	
5"	CHOC5		CHOGL5		N/A	
6"	CHOC6		CHOGL6		N/A	

Plain Conductor Head with Oval Outlet* - 3" - 6 pcs. per ctn. 4" - 4 pcs. per ctn. 5" - 3 pcs. per ctn.

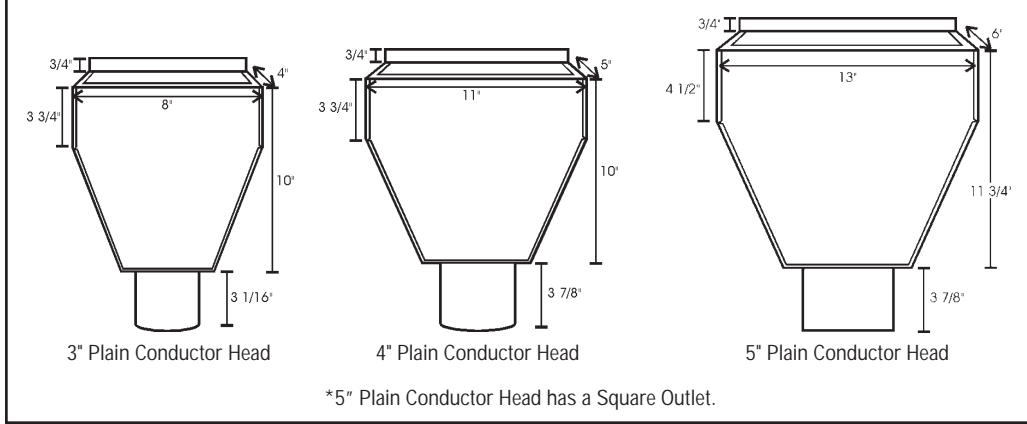

- 3" and 4" Aluminum Available in High Gloss White (HG) and Royal Brown (BR).
 - 5" Aluminum Available in High Gloss White Only.
- ENTER COLOR CODE WHEN ORDERING**

Metal:	Painted Aluminum	
Size	Code	Price
3"	CHO___3	
4"	CHO___4	
5"	CHOHG5	

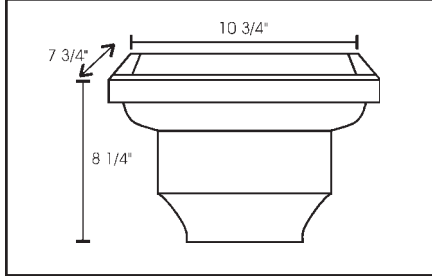

Molded Universal Conductor Head

- Available in White Only.
 - Suited for Any Outlet Shape or Size.
- | Polypropylene "Plastic" | |
|-------------------------|-------|
| Code | Price |
| CHFMUW | |

GUTTER ACCESSORIES

"K" STYLE & HALF ROUND EAVE BOXES / FUNNELS

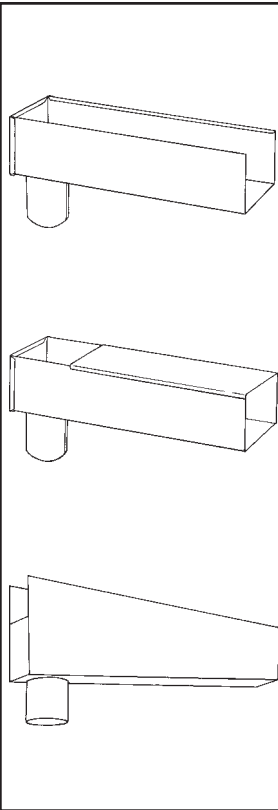

Regular (Open), Closed and Sloped Eave Boxes -
Regular & Closed - 12 pcs. per ctn. Sloped - 6 pcs. per ctn.

- All Painted Aluminum Available in High Gloss White Only.

Metal:	Painted Aluminum		Copper	
Size	Code	Price	Code	Price
REGULAR (OPEN)				
3" x 12"	EBWA32		EBCP32	
3" x 16"	EBWA36		EBCP36	
4" x 12"	EBWA42		EBCP42	
4" x 16"	EBWA46		EBCP46	
CLOSED				
3" x 16"	CBWA36		CBCP36	
4" x 16"	CBWA46		CBCP46	
SLOPED				
3" x 16"	SBWA36		SBCP36	
4" x 16"	SBWA46		SBCP46	

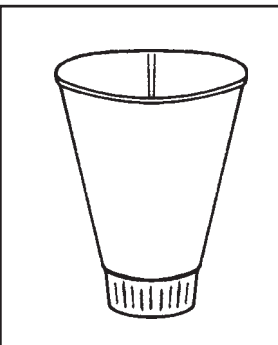

Oval Funnel - 12 pcs. per ctn.

- Painted Aluminum is Available in White (WA) and Royal Brown (BR).

ENTER COLOR CODE WHEN ORDERING

Metal:	Painted Aluminum		Copper		Galvanized Steel	
Size	Code	Price	Code	Price	Code	Price
3"	FUN___3		FUNCP3		FUNGL3	
4"	FUN___4		N/A		FUNGL4	



Funnel - 12 pcs. per ctn.

- 3" & 4" Painted Aluminum are Available in 21 Standard Colors:
 - 30° White Low Gloss • 80° White High Gloss • Antique Ivory • Almond • Beaver Brown • Buckskin Brown
 - Terratone Bronze • CB Gray • Clay • Cream • Dark Bronze • Grecian Green • Herringbone • Bone Linen
 - Musket Brown • Pearl Gray • Royal Brown • Red • Tuxedo Gray • Wicker • Black.
- All Colors can be Manufactured. Most Colors are Typically in Stock. Some Colors May Require a Minimum Quantity and/or Extended Lead Time.

Metal:	Painted Aluminum	
Size	Code	Price
3"	Call for Code	
4"	Call for Code	

GUTTER ACCESSORIES

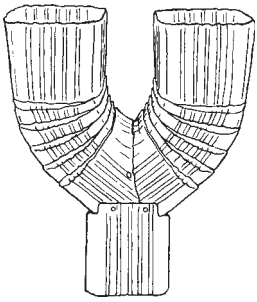

Square "Y" Funnel - 12 pcs. per ctn.

- Painted Aluminum is Available in High Gloss White (HG), Low Gloss White (LG) and Royal Brown (BR).

ENTER COLOR CODE WHEN ORDERING

Metal:	Painted Aluminum	
Size	Code	Price
2" x 3"	SCY__3	
3" x 4"	SCY__4	

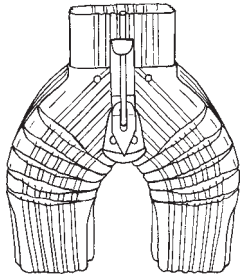

Square Cutoff with Diverter - 12 pcs. per ctn.

- Painted Aluminum is Available in High Gloss White (WA), Low Gloss White (LG) and Royal Brown (BA).

ENTER COLOR CODE WHEN ORDERING

Metal:	Painted Aluminum	
Size	Code	Price
2" x 3"	SAC__3	
3" x 4"	SAC__4	

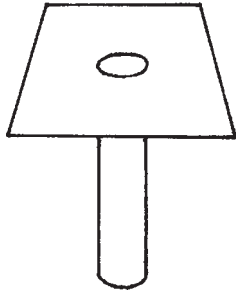

Downspout Tube - 12 pcs. per ctn.

- Painted Aluminum is Available in White Only.

Metal:	Painted Aluminum		Copper		Galvanized Steel	
Size	Code	Price	Code	Price	Code	Price
2"	DSTWA2		DSTCP2		DSTGL2	
3"	DSTWA3		DSTCP3		DSTGL3	
4"	DSTWA4		DSTCP4		DSTGL4	



Square-To-Round Tile Adapter - 20 pcs. per bag

- Typically Used for Transitioning from 3" x 4" Downspout to 4" Corrugated Underground PVC Tubing.
- Sold in Full Bag Quantities Only.

PVC:	Black	
Size	Code	Price
3" x 4" to 4"	4TA	

GUTTER ACCESSORIES

“K” STYLE & HALF ROUND PIPE FASTENERS

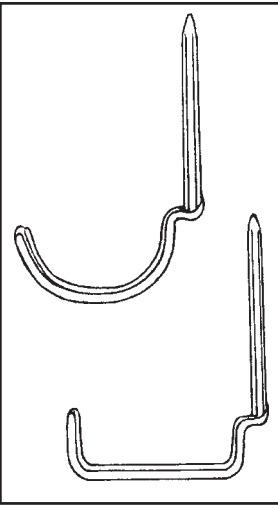

Brick Hook - ROUND and SQUARE - 50 pcs. per ctn.

- Painted Galvanized is Available in White Only.

Metal:	Galvanized Steel		Painted Galvanized Steel	
Size	Code	Price	Code	Price
ROUND				
3"	BPRGL3		BPRWS3	
4"	BPRGL4		BPRWS4	
SQUARE				
2" x 3"	BPSGL3		BPSWS3	
3" x 4"	BPSGL4		BPSWS4	

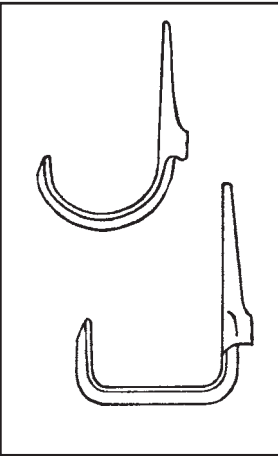

Stamped Sickle Hook for Wood - ROUND and SQUARE - 50 pcs. per ctn.

Metal:	Galvanized Steel		Painted Galv. - White		Painted Galv. - Royal Brown	
Size	Code	Price	Code	Price	Code	Price
ROUND						
3"	PWHGL3		PWHWS3		PBRSH3	
4"	PWHGL4		PWHWS4		PBRSH4	
SQUARE						
2" x 3"	SSWGL3		SSWWS3		SHBRA3	
3" x 4"	SSWGL4		SSWWS4		SHBRA4	

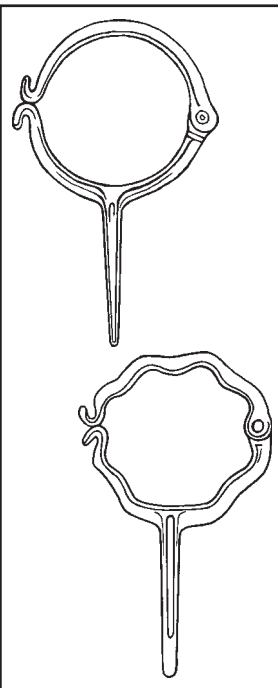

Plain Round and Round Corrugated Hinged Downspout Hook - 3" & 4" - 50 pcs./ctn. 5" - 25 pcs./ctn.

- Non-Stock Item. Please Allow Extended Lead Time.
- Coppered – Copper Plated Zinc Alloy.
- Must be Purchased in Full Box Quantities.

Metal:	Coppered		Zinc	
Size	Code	Price	Code	Price
PLAIN ROUND				
3"	HHPRC3		HHPRZ3	
4"	HHPRC4		HHPRZ4	
5"	HHPRC5		N/A	
ROUND CORRUGATED				
3"	HHRCC3		HHRCZ3	
4"	HHRCC4		HHRCZ4	
5"	HHRCC5		N/A	

GUTTER ACCESSORIES



“K” STYLE & HALF ROUND PIPE FASTENERS

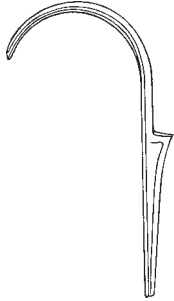

Plain Round Cast Bronze Sickle Hook - 25 pcs per ctn.

- Non-Stock Item. Please Allow Extended Lead Time.
- Must be Purchased in Full Box Quantities.

Metal:	Bronze	
Size	Code	Price
4"	PWHBZ4	
6"	PWHBZ6	

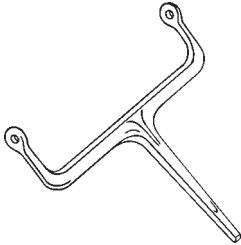

2" x 3" and 3" x 4" Square Side-Fasten Hook - 50 pcs. per ctn.

- Non-Stock Item. Please Allow Extended Lead Time.
- Copper Plated Zinc Alloy.
- Must be Purchased in Full Box Quantities.

Metal:	Coppered	
Size	Code	Price
2" x 3"	SFHC23	
3" x 4"	SFHC34	

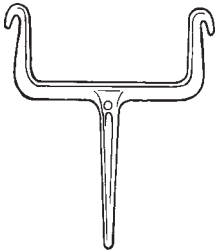

Square Wired Wood/Brick Hook - 2" x 3" and 3" x 4" - 50 pcs. per ctn. 4" x 5" - 25 pcs. per ctn.

- Non-Stock Item. Please Allow Extended Lead Time.
- Copper Plated Zinc Alloy.
- Must be Purchased in Full Box Quantities.

Metal:	Coppered	
Size	Code	Price
2" x 3"	WFHC23	
3" x 4"	WFHC34	
4" x 5"	WFHC45	

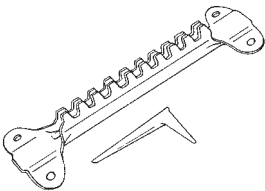

Rack & Key - 50 pcs. per ctn.

- Aluminum is Available in High Gloss White (-WA), Royal Brown (BRA) and Mill Finished (-MF).
- Two Racks are Recommended per 10 ft. Downspout Section.
- FreedomGray® Copper – This accessory item is not formed from FreedomGray® coil or sheet product. It is formed from copper product that is then plated with a Tin Zinc coating to provide similar color and properties. FreedomGray® is a registered trademark of Revere Copper Products, Inc.

ENTER COLOR CODE WHEN ORDERING

Metal:	Aluminum		Copper		FreedomGray® Copper		Galvanized Steel	
Size	Code	Price	Code	Price	Code	Price	Code	Price
One Size	RAK_ _ _ _		RAK-CP		RAK-FG		RAK-CS	



Key - 50 pcs. per ctn.

Metal:	Mill Finished Aluminum		Bronze (Used w/ Copper)	
Size	Code	Price	Code	Price
One Size	KEY-MF		KEY-BR	

GUTTER ACCESSORIES

"K" STYLE & HALF ROUND PIPE FASTENERS

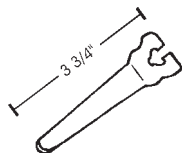

#0 Masonry Drive - 50 pcs. per ctn.

- Requires Rack & Key to Install.
- Two Drives are Recommended per 10 ft. Downspout Section.

Bronze		Galvanized Steel	
Code	Price	Code	Price
DR-BR0		DRCS-0	

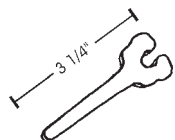

#4 Wood Drive - 50 pcs. per ctn.

- Requires Rack & Key to Install.
- Two Drives are Recommended per 10 ft. Downspout Section.

Copper		Galvanized Steel	
Code	Price	Code	Price
DRCP-4		DRCS-4	

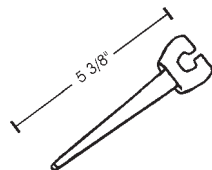

#5 Wood Drive - 50 pcs. per ctn.

- Requires Rack & Key to Install.
- Two Drives are Recommended per 10 ft. Downspout Section.

Malleable Iron	
Code	Price
DR-CM5	

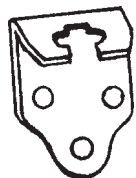

#6 Drive - 50 pcs. per ctn.

- Aluminum Available in High Gloss White (**WA-**), Royal Brown (**BRA**) and Mill Finished (**MF-**).
- Painted Galvanized Steel Available in White Only.
- Requires Rack & Key to Install.
- Two Drives are Recommended per 10 ft. Downspout Section.

ENTER COLOR CODE WHEN ORDERING

Aluminum		Copper		Galvanized Steel		Painted Galvanized Steel	
Code	Price	Code	Price	Code	Price	Code	Price
DR___6		DRCP-6		DRCS-6		DRWS-6	



2" x 3" and 3" x 4" Pipe Clips - 50 pcs. per ctn.

- Painted Aluminum is Available in 21 Standard Colors:
 - 30° White Low Gloss • 80° White High Gloss • Antique Ivory • Almond • Beaver Brown • Buckskin Brown
 - Terratone Bronze • CB Gray • Clay • Cream • Dark Bronze • Grecian Green • Herringbone • Bone Linen
 - Musket Brown • Pearl Gray • Royal Brown • Red • Tuxedo Gray • Wicker • Black.
- Two Brackets are Recommended per 10 ft. Downspout Section.

ENTER COLOR CODE WHEN ORDERING

Metal:	Painted Aluminum		Copper	
Size	Code	Price	Code	Price
2" x 3"	Call for Code		3PCC	
3" x 4"	Call for Code		4PCC	

GUTTER ACCESSORIES



"K" STYLE & HALF ROUND PIPE FASTENERS

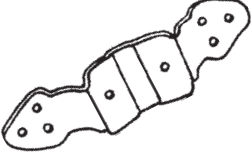

#31 Pipe Cleat - 50 pcs. per ctn.

- Painted Aluminum is Available in High Gloss White (HG) and Brown (BR).
- Two Pipe Cleats are Recommended per 10 ft. Downspout Section.

ENTER COLOR CODE WHEN ORDERING

Painted Aluminum		Copper	
Code	Price	Code	Price
PC__31		PCCP31	



#32 Pipe Cleat - 50 pcs. per ctn.

- Painted Aluminum is Available in Brown (0) and White (5).

ENTER COLOR CODE WHEN ORDERING

Painted Aluminum		Copper	
Code	Price	Code	Price
706__		7070	

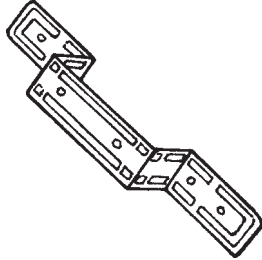

Universal Conductor Band - 50 pcs. per ctn.

- Aluminum is Available in High Gloss White (WA), Low Gloss White (LG), Royal Brown (BA), Dark Bronze (DB) and Mill Finished (MF).
- Painted Galvanized Steel is Available in White (WS) and Brown (BS).
- Use for 3", 4", 2" x 3" or 3" x 4" Downspout.
- Two Conductor Bands are Recommended per 10 ft. Downspout Section.

ENTER COLOR CODE WHEN ORDERING

Aluminum		Copper		Galvanized Steel		Painted Galvanized Steel	
Code	Price	Code	Price	Code	Price	Code	Price
__12CB		CP12CB		GA12CB		__12CB	



Metco Ornamental Conductor Bands - 100 pcs. per ctn.

- Painted Aluminum is Available in High Gloss White (HG), Royal Brown (BR) and Dark Bronze (DB).
- Two Conductor Bands are Recommended per 10 ft. Downspout Section.

ENTER COLOR CODE WHEN ORDERING

Metal:	Painted Aluminum		Copper		Galvanized Steel	
Size	Code	Price	Code	Price	Code	Price
3"	MET__3		METCP3		METGA3	
4"	MET__4		METCP4		METGA4	



Ornamental Pipe Band - 100 pcs. per ctn.

- Painted Aluminum is Available in 21 Standard Colors:
 - 30° White Low Gloss • 80° White High Gloss • Antique Ivory • Almond • Beaver Brown • Buckskin Brown
 - Terratone Bronze • CB Gray • Clay • Cream • Dark Bronze • Grecian Green • Herringbone • Bone Linen
 - Musket Brown • Pearl Gray • Royal Brown • Red • Tuxedo Gray • Wicker • Black.
- Two Conductor Bands are Recommended per 10 ft. Downspout Section.

.018 Painted Aluminum		Copper	
Code	Price	Code	Price
Call for Code		OPBC	

GUTTER ACCESSORIES

"K" STYLE & HALF ROUND PIPE FASTENERS / MISC. ACCESSORIES

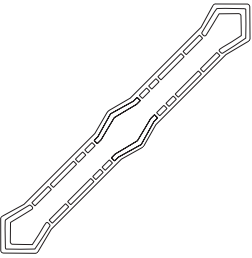

Diamond Pipe Band - 100 pcs. per ctn.

- Painted Aluminum is Available in 21 Standard Colors: • 30° White Low Gloss • 80° White High Gloss • Antique Ivory • Almond • Beaver Brown • Buckskin Brown • Terratone Bronze • CB Gray • Clay • Cream • Dark Bronze • Grecian Green • Herringbone • Bone Linen • Musket Brown • Pearl Gray • Royal Brown • Red • Tuxedo Gray • Wicker • Black.
- Use for 3", 4", 2" x 3" or 3" x 4" Downspout.

Painted Aluminum	
Code	Price
Call for Code	

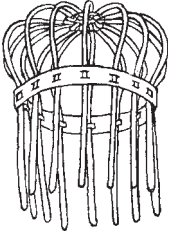

Wire Strainers - ROUND - 2", 3" & 4" - 50 pcs./ctn. 5" & 6" - 20 pcs./ctn.

- Round Strainers can be used in Square Holes when Reformed by Hand.

Metal:	Mill Finished Aluminum		Copper		Galvanized Steel	
Size	Code	Price	Code	Price	Code	Price
2"	RWSMF2		RWSCP2		RWSGL2	
3"	RWSMF3		RWSCP3		RWSGL3	
4"	RWSMF4		RWSCP4		RWSGL4	
5"	RWSMF5		RWSCP5		RWSGL5	
6"	RWSMF6		RWSCP6		RWSGL6	



K-Style Perforated Strainer - 50 pcs. per ctn.

- Aluminum Available in Mill Finished Only.

Metal:	Aluminum	
Size	Code	Price
5"	74065	



Tin Plate Roofing Button - 25 lbs. per ctn.

Metal:	Aluminum	
Size	Code	Price
1-5/8"	5030	



#42 Pop Rivet 1 1/2" - Aluminum 1,000 pcs./ctn. Stainless Steel 100 pcs./ctn. Copper & Galvanized Steel 500 pcs./ctn.

- 3" & 4" Painted Aluminum are Available in 21 Standard Colors:
 - 30° White Low Gloss • 80° White High Gloss • Antique Ivory • Almond • Beaver Brown • Buckskin Brown • Terratone Bronze • CB Gray • Clay • Cream • Dark Bronze • Grecian Green • Herringbone • Bone Linen • Musket Brown • Pearl Gray • Royal Brown • Red • Tuxedo Gray • Wicker • Black.
- All Colors can be Manufactured. Most Colors are Typically in Stock. Some Colors May Require a Minimum Quantity and/or Extended Lead Time.

Painted Aluminum		Copper		Galvanized Steel		Stainless Steel	
Code	Price	Code	Price	Code	Price	Code	Price
Call for Code		A42CPB		A42GLB		A42SSB	

GUTTER ACCESSORIES



"K" STYLE & HALF ROUND MISCELLANEOUS ACCESSORIES



#44 Pop Rivet 1 5/8" - Aluminum 1,000 pcs./ctn. Copper 500 pcs./ctn.

- Painted Aluminum Available in White (BW), Royal Brown (BB) and Dark Bronze (DB).

ENTER COLOR CODE WHEN ORDERING

Painted Aluminum		Copper	
Code	Price	Code	Price
A44A__		A44CPB	

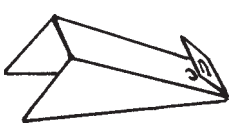

Short Gutter Wedge - 100 pcs. per ctn.

- Painted Aluminum Available in White (W) and Brown (B).

ENTER COLOR CODE WHEN ORDERING

Painted Aluminum	
Code	Price
GW-__A	



Tall Gutter Wedge - 100 pcs. per ctn.

- Painted Aluminum Available in Brown (3) and White (4).

ENTER COLOR CODE WHEN ORDERING

Painted Aluminum	
Code	Price
93__00	

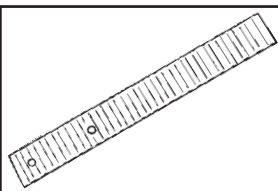

Duplex Wall Ties - 500 pcs. per ctn.

28 ga. Galvanized Steel	
Code	Price
94575	

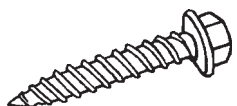

1/2" Zip Screws - 1000 pcs. per box

- Painted Aluminum is Available in 21 Standard Colors:
 - 30° White Low Gloss • 80° White High Gloss • Antique Ivory • Almond • Beaver Brown • Buckskin Brown • Terratone Bronze • CB Gray • Clay • Cream • Dark Bronze • Grecian Green • Herringbone • Bone Linen • Musket Brown • Pearl Gray • Royal Brown • Red • Tuxedo Gray • Wicker • Black.
- Some Colors May Require a Minimum Quantity and/or Extended Lead Time.

Metal:	Painted Aluminum	
Size	Code	Price
1/2"	Call for Code	

GUTTER ACCESSORIES

“K” STYLE & HALF ROUND MISCELLANEOUS ACCESSORIES

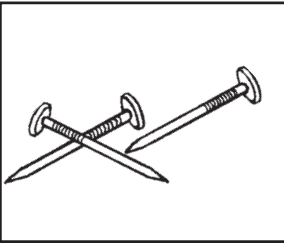

1" Trim Nails - 1 lb. box

- Aluminum Available in White Only.

Metal:	Painted Aluminum	
Size	Code	Price
1"	100WAW	



1 1/4" Trim Nails - Alum. & Stain. Steel - 1 lb. box

- Aluminum Available in White (**WAW**) and Brown (**BAW**).
- Painted Stainless Steel Available in Brown (**00**), Almond (**01**), Black (**05**), Bronze (**10**), Cream (**20**), Forest Green (**25**), Wineberry (**60**) and White (**70**).

ENTER COLOR CODE WHEN ORDERING

Metal:	Painted Aluminum		Painted Stainless Steel	
Size	Code	Price	Code	Price
1 1/4"	114___		773___	

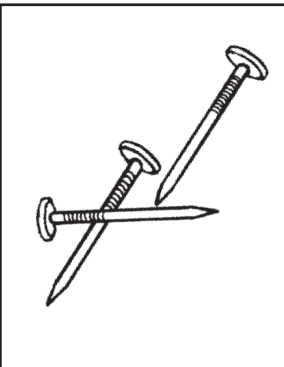

1 1/4" Trim Nails - Alum. & Copper - 1/4 lb. box

- Painted Aluminum is Available in 21 Standard Colors:
 - 30° White Low Gloss • 80° White High Gloss • Antique Ivory • Almond • Beaver Brown • Buckskin Brown
 - Terratone Bronze • CB Gray • Clay • Cream • Dark Bronze • Grecian Green • Herringbone • Bone Linen
 - Musket Brown • Pearl Gray • Royal Brown • Red • Tuxedo Gray • Wicker • Black.
- All Colors can be Manufactured. Most Colors are Typically in Stock. Some Colors May Require a Minimum Quantity and/or Extended Lead Time.

Metal:	Painted Aluminum		Copper	
Size	Code	Price	Code	Price
1 1/4"	Call for Code		114CPP	



Gutter Mastic 5 oz. Squeeze Tubes - 24 pcs. per ctn.

- Available in Clear (**CL**), White (**WA**) and Gray (**GR**).

ENTER COLOR CODE WHEN ORDERING

Code	Price
MAS___5	

GUTTER ACCESSORIES



“K” STYLE & HALF ROUND MISCELLANEOUS ACCESSORIES



SeamerMate® 10 oz. Caulk Gun Cartridge - 12 pcs. per ctn.

- Available in Gray Only.

Code	Price
SMMTGR	



FlashMate® 10 oz. Caulk Gun Cartridge - 12 pcs. per ctn.

- Available in Clear Only.

Code	Price
85228	



Touch-Up Paint 12 oz. Cans - 12 pcs. per ctn.

- Painted Aluminum is Available in 21 Standard Colors:
- 30° White Low Gloss • 80° White High Gloss • Antique Ivory • Almond • Beaver Brown • Buckskin Brown
- Terratone Bronze • CB Gray • Clay • Cream • Dark Bronze • Grecian Green • Herringbone • Bone Linen
- Musket Brown • Pearl Gray • Royal Brown • Red • Tuxedo Gray • Wicker • Black.

Code	Price
Call for Code	

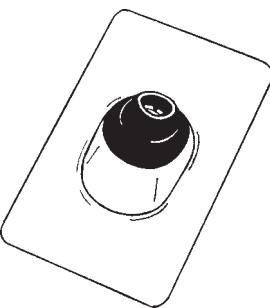

No-Caulk Pipe Flashing - 12 pcs. per ctn.

Metal:	Mill Finished Aluminum	
Size	Code	Price
1 1/2"	OMFN15	
2"	OMFN20	
3"	OMFN30	
4"	OMFN40	



Ladder-Max Universal Ladder Stabilizer - 1 pc. per ctn.

- The galvanized steel Ladder-Max Ladder Stand-Off Stabilizer Helps Improve Efficiency and Facilitates Ladder Productivity
- Size: 20-3/4"h x 38-1/2"w, Weight: 7 lbs. 11 oz.
- Stand-Off Depth is 19"
- OSHA and ANSI Certified and Easily Attaches and Detaches without Tools to Most Ladder Styles

Code	Price
LADMAX	

GUTTER ACCESSORIES

“K” STYLE & HALF ROUND GUTTER GUARDS

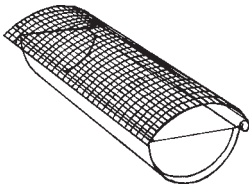

Half Round Hinged Gutter Guard - Aluminum 50 pcs. per ctn. - Copper 25 pcs. per ctn. - 3' long ea.

Metal:	Mill Finished Aluminum		Copper	
Size	Code	Price	Code	Price
5" HR	GGAR-5		GGCR-5	
6" HR	GGAR-6		GGCR-6	

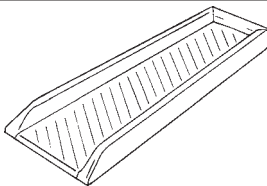

Splash Blocks

Green		Brown		Gray	
Code	Price	Code	Price	Code	Price
SBGN06		SBBR07		SBGR34	

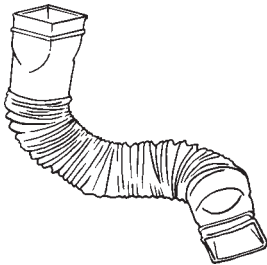

Flex-A-Spout - 12 pcs. per ctn.

- Available in Brown (BR), Green (GR) and White (WH).
- Can be Used with 2" x 3" and 3" x 4" Downspout.
- Expands to 54" in Length.
- Sold in Full Box Quantities Only.

ENTER COLOR CODE WHEN ORDERING

Brown		Green		White	
Code	Price	Code	Price	Code	Price
FLXSBR		FLXSGR		FLXSWH	

Notes:
The purpose of our Gutter Guard product line is to stop leaves or reduce debris from entering the gutter/eaves trough. Product performance can vary depending on proper installation, product selection, gutter orientation, roof material and slope. Winter weather may cause snow and ice to accumulate at roof eaves. Ice damming can result from improper roof ventilation and inadequate insulation. Heat radiating from below the roof and sun radiation melt snow and it freezes again when temperatures drop below freezing (0°C/32°F degrees). Icicles can be formed on roof edges due to these conditions whether or not gutters or guards are installed. This is a natural process beyond the manufacturers control and we accept no responsibility for ice and snow accumulation or related consequences.

Leaf Guards are sold as debris protection devices. The manufacturer assumes no responsibility for any other result of this product use.

GUTTER ACCESSORIES