

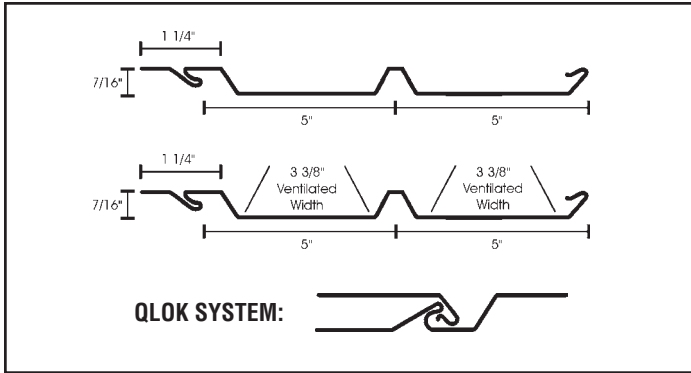

ALUMINUM SOFFIT & ACCESSORIES

SOFFIT AND VENTILATION PRODUCTS



10" QLOK .019 Aluminum Soffit -
 120'/ctn. 1 sq./ctn. 10 pcs./ctn. 12' per piece
 9.6 In² Net Free Area/Ft²

- Available in White (WA), Royal Brown (BA), Dark Bronze (DB), and Clay (CL).

ENTER COLOR CODE WHEN ORDERING

SOLID (NON-VENTILATED)		VENTILATED	
Code	Price	Code	Price
QS10__		QV10__	

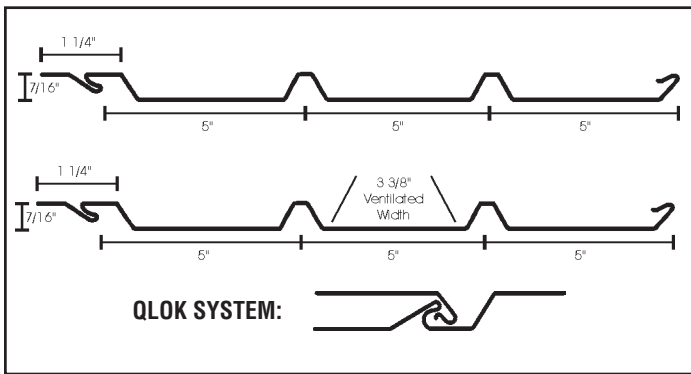

15" QLOK .019 Aluminum Soffit -
 120'/ctn. 1.5 sqs./ctn. 10 pcs./ctn. 12' per piece
 4.8 In² Net Free Area/Ft²

- Available in White (WA) and Royal Brown (BA).

ENTER COLOR CODE WHEN ORDERING

SOLID (NON-VENTILATED)		VENTILATED	
Code	Price	Code	Price
QS15__		QV15__	

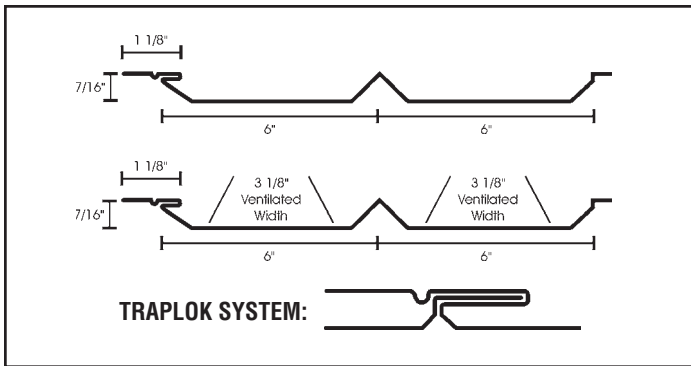

12" TRAPLOK .019 Aluminum Soffit -
 120'/ctn. 1.2 sqs./ctn. 10 pcs./ctn. 12' per piece
 3.5 In² Net Free Area/Ft²

- Available in White (WA), Royal Brown (BA) and Dark Bronze (DB).

ENTER COLOR CODE WHEN ORDERING

SOLID (NON-VENTILATED)		VENTILATED	
Code	Price	Code	Price
SV12__		LV12__	

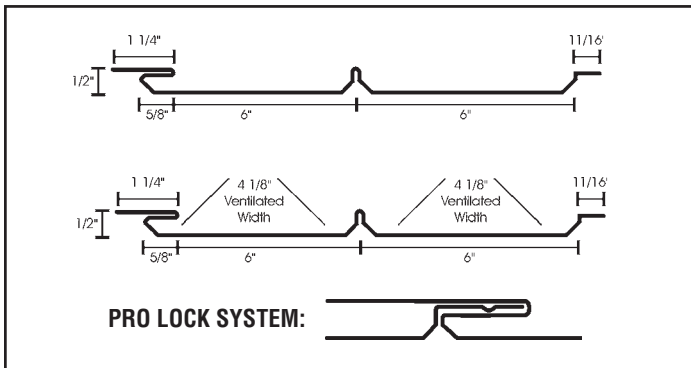

12" PRO LOCK V-Groove 16 Oz. Copper Soffit -
 Custom Lengths 8.8 In² Net Free Area/Ft²

Berger will manufacture our Copper Soffit to size for your job. This product is not for use as vertical siding and cannot be run in lengths longer than 24 inches unless specifically engineered and quoted for the job. Please call for availability.

- This is a Non-Stock Item and may Require Extended Lead Time.

SOLID (NON-VENTILATED)		VENTILATED	
Code	Price	Code	Price
SS12C2		SV12C2	

PRODUCT INFORMATION:

- QLOK style is recommended for use in coastal or windy environments.
- Attachment of soffit requires nailing on 12" centers when used in areas subjected to wind uplift and vibration.
- Short soffit overhangs of 16" or less require at least 1 nail per piece central of the hem.

ALUMINUM SOFFIT & ACCESSORIES

SOFFIT AND VENTILATION PRODUCTS

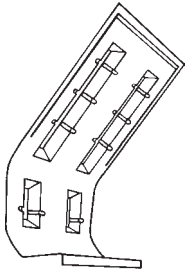

AccuVent™ Soffit Insulation Baffle - 50 pcs./bundle - 56 bundles/skid

- AccuVent is 22.5" x 41" and Fits Any Size Roof or Truss
- Installs with Six Staples
- Perforated for Adjusted Roof Truss Spacing

100% Recycled PVC	
Code	Price
ACCUVENT	

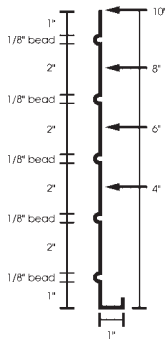

.024 Aluminum Fascia - 300'/ctn. 25 pcs./ctn.

- 4" Fascia is Available in White (WA) and Royal Brown (BA).
- 6" Fascia is Available in White (WA), Royal Brown (BA), Musket Brown (MB) and Clay (CL).
- 8" Fascia is Available in White (WA), Clay (CL) and Royal Brown (BA).
- 10" Fascia is Available in White (WA), Royal Brown (BA) and Dark Bronze (DB).
- Note: 8" Clay Fascia is 12 pcs./ctn..

ENTER COLOR CODE WHEN ORDERING

4"		6"		8"		10"	
Code	Price	Code	Price	Code	Price	Code	Price
FAS4__		FAS6__		FAS8__		FAS1__	

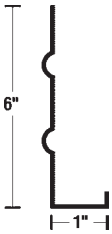

.019 Aluminum Fascia - 300'/ctn. 25 pcs./ctn.

- 6" Fascia is Available in White (WA), Desert Tan (DT), Granite Gray (GR), Ivy Green (IG), Light Bronze (LB), Natural Clay (NC), Prairie Sand (PS) and Sandstone Beige (SB).

ENTER COLOR CODE WHEN ORDERING

6"	
Code	Price
FA96__	

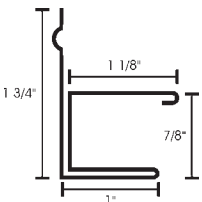

.019 Aluminum 1/2 "F" Channel - 300'/ctn. 25 pcs./ctn.

- Painted Aluminum is Available in White (-W), Brown (-B), Clay (CL), Dark Bronze (DB) and Light Bronze (LB).

ENTER COLOR CODE WHEN ORDERING

Code	Price
FA50__	

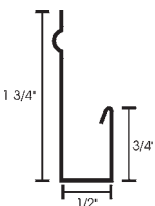

.019 Aluminum 1/2 "J" Channel - 600'/ctn. 50 pcs./ctn.

- Painted Aluminum is Available in White (-W) and Royal Brown (-B).

ENTER COLOR CODE WHEN ORDERING

Code	Price
JA50__	



ALUMINUM SOFFIT & ACCESSORIES

SOFFIT AND VENTILATION PRODUCTS

.019 Aluminum 1/2 Economy "J" Channel - 600'/ctn. 50 pcs./ctn.

- Painted Aluminum is Available in White (**EW**), Brown (**BA**), Clay (**CL**), Dark Bronze (**DB**), Desert Tan (**DT**), Sandstone Beige (**SB**) and 16 Oz. Copper (**CP**).

ENTER COLOR CODE WHEN ORDERING

Code	Price
JA50__	

.019 Aluminum 3/4 "J" Channel - 600 ft. per ctn.

- Painted Aluminum is Available in White Only.

Code	Price
J-34WA	

Starter Strip - 10' Aluminum 400 ft. per ctn. - 10' Galvanized Steel 250 ft. per ctn. - 10' Galvanized Steel 200 ft. per ctn.

- Aluminum and Galvanized Steel Starter Strips Have Nail Holes or Slots
- GLSS118 is 250 ft. per ctn. and GLSS10N is 200 ft. per ctn.

Metal:	Aluminum - 10'		Aluminum - 12'		Galvanized Steel - 10'	
Width	Code	Price	Code	Price	Code	Price
3"	ALSS10		ALSS12		GLSS10N	
3.5"	ALS118		N/A		GSS118	

Starter Strip - Galvanized Steel 250 ft. per ctn.

- Galvanized Steel Starter Strip **Does Not have Nail Holes or Slots**

Metal:	Galvanized Steel - 10'	
Width	Code	Price
3"	GLSS10	

Aluminum Soffit Cove Moulding - 25 per ctn. - 300 ft. per ctn.

- Painted Aluminum is Available in White (**W**) and Royal Brown (**B**) and is .019.

Code	Price
RCM__12	

Aluminum Utility Trim - 600 ft. per ctn.

- Painted Aluminum is Available in White Only.

Code	Price
UT19WA	