

HOW PRO-MASTER RIDGE VENT™ WORKS:

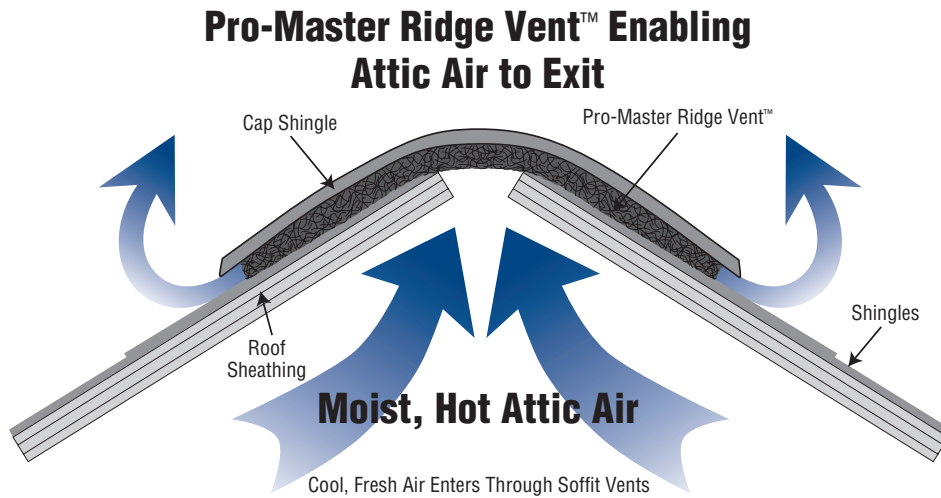

PRO-MASTER RIDGE VENT™ INSTALLATION:

1. Remove ridge cap shingles along entire length of ridge.
2. a) Measure 1" from ridge peak on each side of ridge. For ridge board construction measure 1-1/2" on each side of ridge.
b) Snap chalk line along entire length of ridge.
c) Leave a minimum of 12" of sheathing closed at each end of ridge.
d) Cut opening in sheathing along ridge. DO NOT CUT through roof trusses or ridge board.
e) Remove sheathing to create slot.
3. Tack one end of the Pro-Master Ridge Vent™ (netting side down) over the slot to hold in place at one end of the ridge. Unroll entire length of vent, pull to remove sags and tack in place so vent is snug and centered over slot. If more than one piece of Ridge Vent is needed, simply butt the multiple pieces together and tack in place with a nail. Cover the entire length of the ridge with vent, including the minimum 12" of unslotted ridge.
4. Install ridge cap shingles directly over Pro-Master Ridge Vent™. Fasten shingle and Ridge Vent to roof using galvanized roofing nails supplied with the ridge vent. Please follow power nailing and safety instructions enclosed with coil nails or use hand nails provided. To obtain a uniform look and prevent shingle damage, do NOT drive nails through shingle.

Note: This product has a net free ventilation area of 15.2 square inches per linear foot. To operate properly, there must be equal or greater soffit ventilation than ridge ventilation.

Installation Tips

Hip Roof Installation

Cut the slot along the ridge to within 12 inches of the end of the ridge. Install Pro-Master Ridge Vent™ along the entire length of the ridge. Do not cut slots or install Ridge Vent along the hips of the roof.

Obstruction Along Ridge

Cut the slots along the ridge to within 12 inches of each side of the obstruction. Install Pro-Master Ridge Vent™ along the ridge, butting up against the obstruction.

T and L Style Roofs

Cut slots along the ridge to within 12 inches of each side of the ridge intersections. First install Pro-Master Ridge Vent™ along the entire long run of the ridge. Then install it along the short run of the ridge so the ridge vent butts up against the Pro-Master Ridge Vent™ already installed on the long run.

Pro-Master Ridge Vent™ Technical Specifications - Patent No. 6,343,985

Material Composition:

Material is composed of natural fibers on a polyester mat joined with latex binding agents plus carbon black for UV resistance.

Codes Met:

ICC* (report ESR-1218)
Texas Department of Insurance (report RV-33)
Miami-Dade, FL (NOA No. 02-0130.01)
UL Class A - Ridge Vents (TGEW)
Florida Building Code (FL2891)

Testing:

Architectural Testing, Inc., York, PA
SGS U.S. Testing Co., Inc., Hoboken, NJ
PRI Asphalt Technologies, Tampa, FL
ETC Laboratories, NY

* The ICC now has the BOCA, ICBO and SBCCI merged into the ICC code.

PRO-MASTER RIDGE VENT™ HIP ROOF INSTALLATION

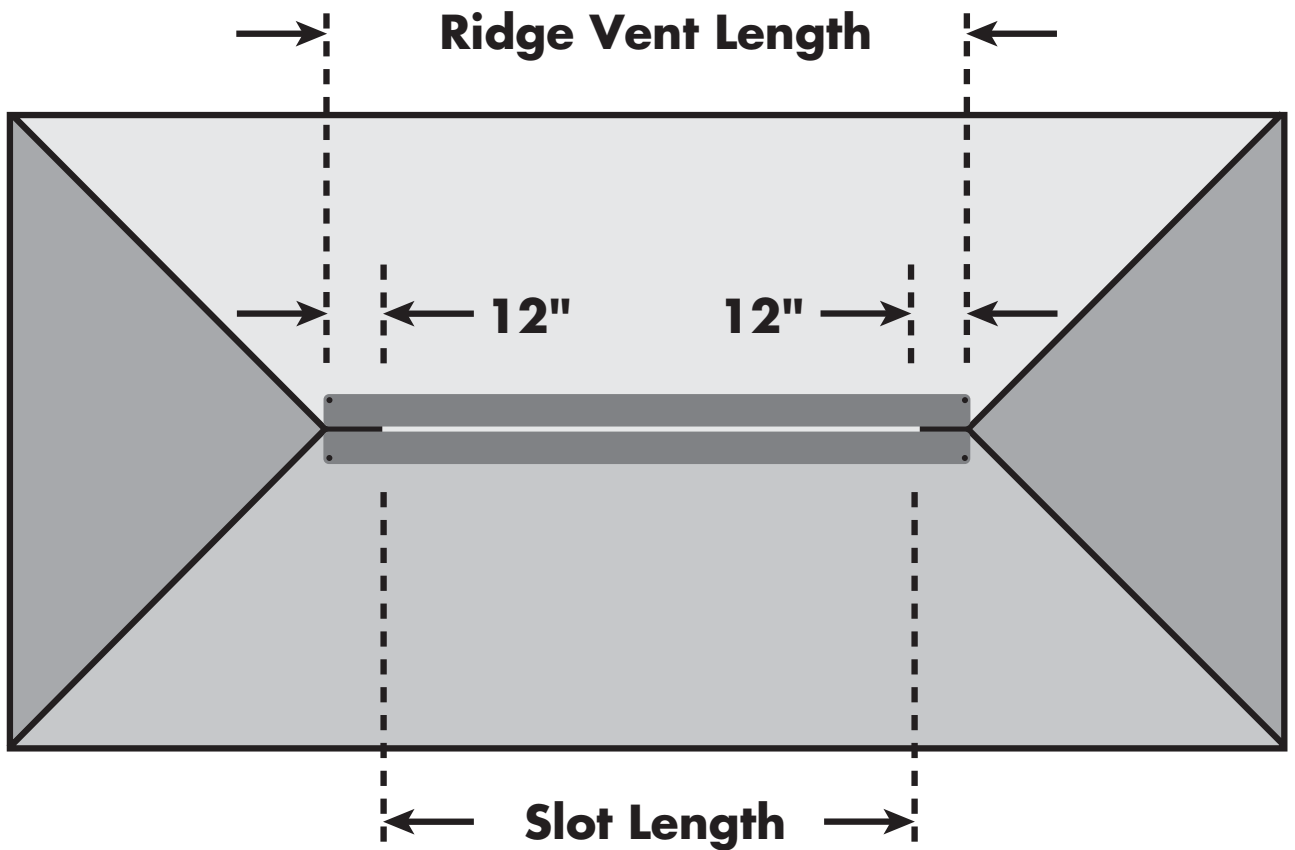

Cut the slot along the ridge to within 12 inches of the end of the ridge. Install Pro-Master Ridge Vent™ along the entire length of the ridge. Do not cut slots or install Ridge Vent along the hips of the roof. Provide ventilation at soffit on all sides.

PRO-MASTER RIDGE VENT™ TYPICAL INSTALLATION: COMP. SHINGLE

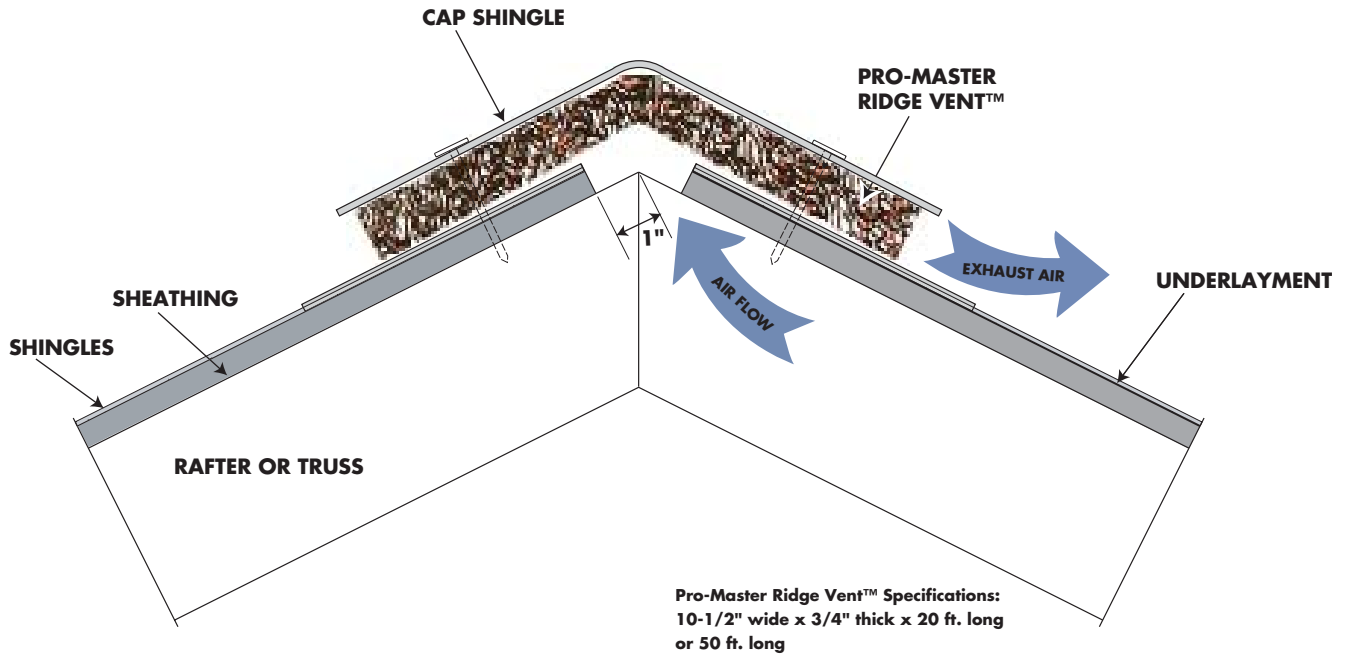

PRO-MASTER RIDGE VENT™ TYPICAL INSTALLATION: COMP. SHINGLE W/ RIDGE BOARD

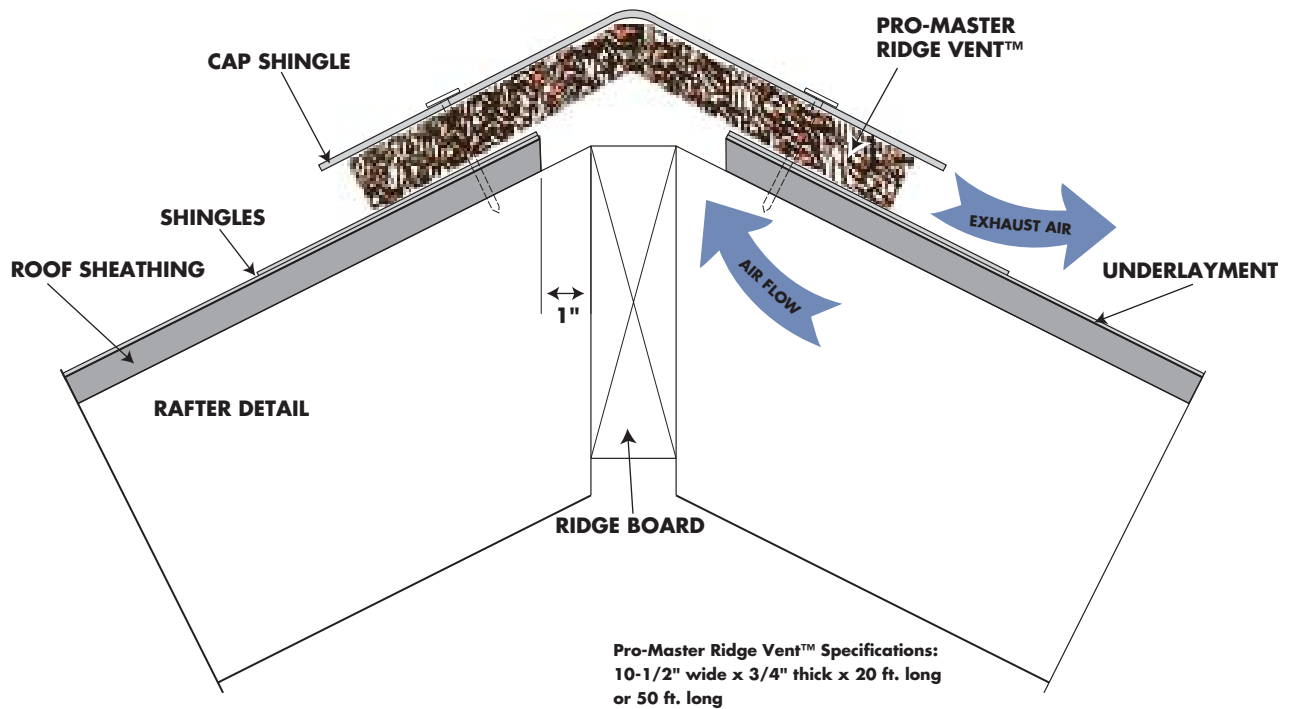

BERGER 805 PENNSYLVANIA BLVD. • FEASTERVILLE, PA 19053 • 800-523-8852		
DATE: 08-01-04	APPROVED BY: A. SWAN	DRAWN BY: SLHD
PRO-MASTER RIDGE VENT™ TYPICAL INSTALLATION: COMP. SHINGLE PRO-MASTER RIDGE VENT™ TYPICAL INSTALLATION: COMP. SHINGLE W/ RIDGE BOARD		

PRO-MASTER RIDGE VENT™ TYPICAL APPLICATION: W/ FLAT TILE ROOF

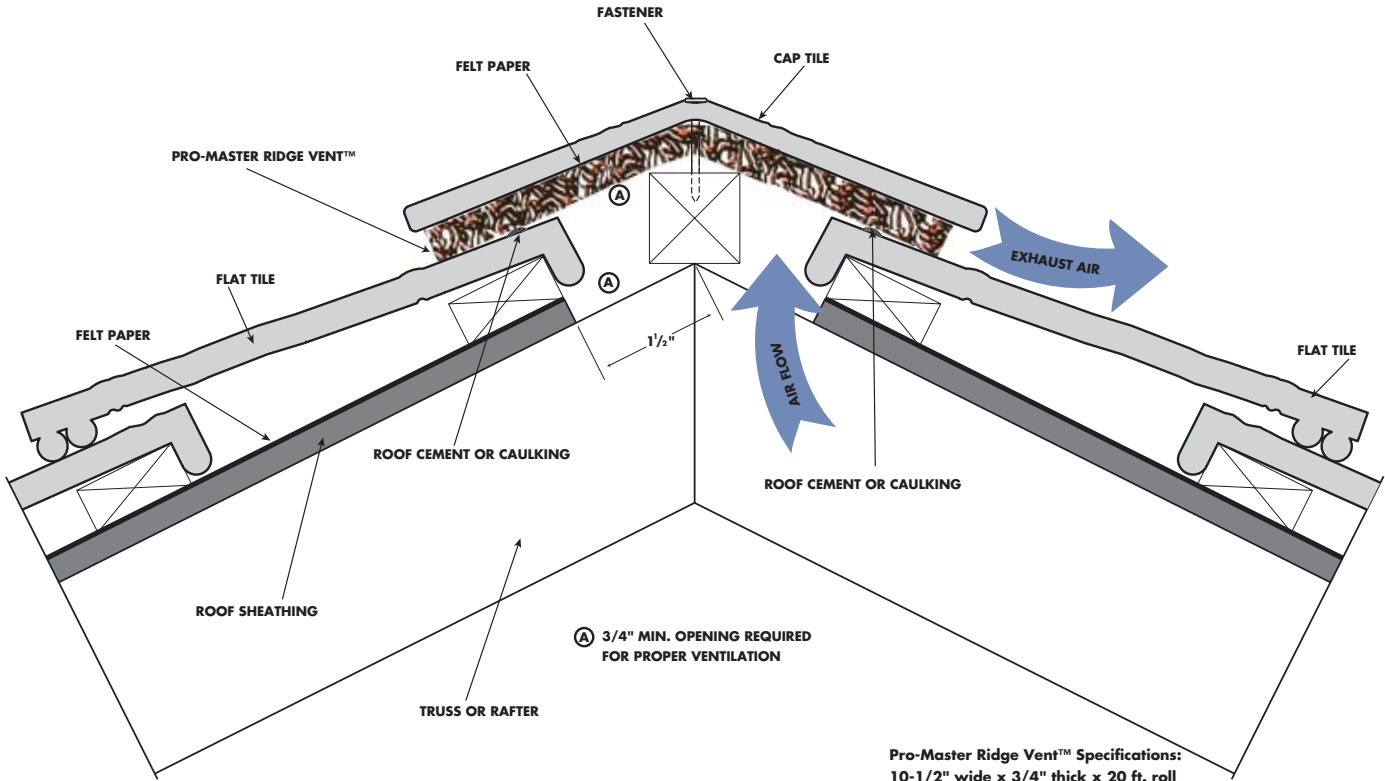

Pro-Master Ridge Vent™ Specifications:
10-1/2" wide x 3/4" thick x 20 ft. roll
or 50 ft. roll

May require trimming of width
depending on tile cap size.

BERGER 805 PENNSYLVANIA BLVD. • FEASTERVILLE, PA 19053 • 800-523-8852		
DATE: 04-01-04	APPROVED BY: A. SWAN	DRAWN BY: SLHD
PRO-MASTER RIDGE VENT™ TYPICAL APPLICATION: W/ FLAT TILE ROOF		

PRO-MASTER RIDGE VENT™ TYPICAL APPLICATION: FLAT TILE ROOF W/ RIDGE BOARD

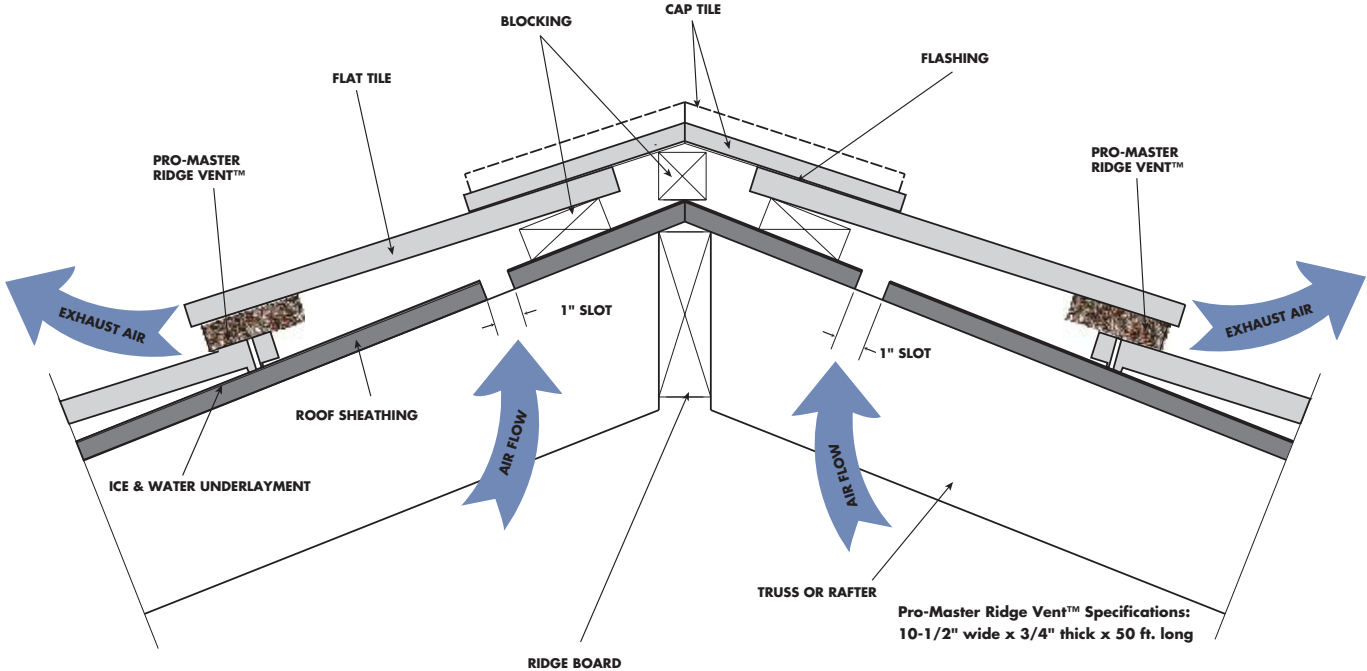

BERGER 805 PENNSYLVANIA BLVD. • FEASTERVILLE, PA 19053 • 800-523-8852		
DATE: 04-01-04	APPROVED BY: A. SWAN	DRAWN BY: SLHD
PRO-MASTER RIDGE VENT™ TYPICAL APPLICATION: FLAT TILE ROOF W/ RIDGE BOARD		

PRO-MASTER RIDGE VENT™ TYPICAL APPLICATION: BARREL OR S-TILE ROOF

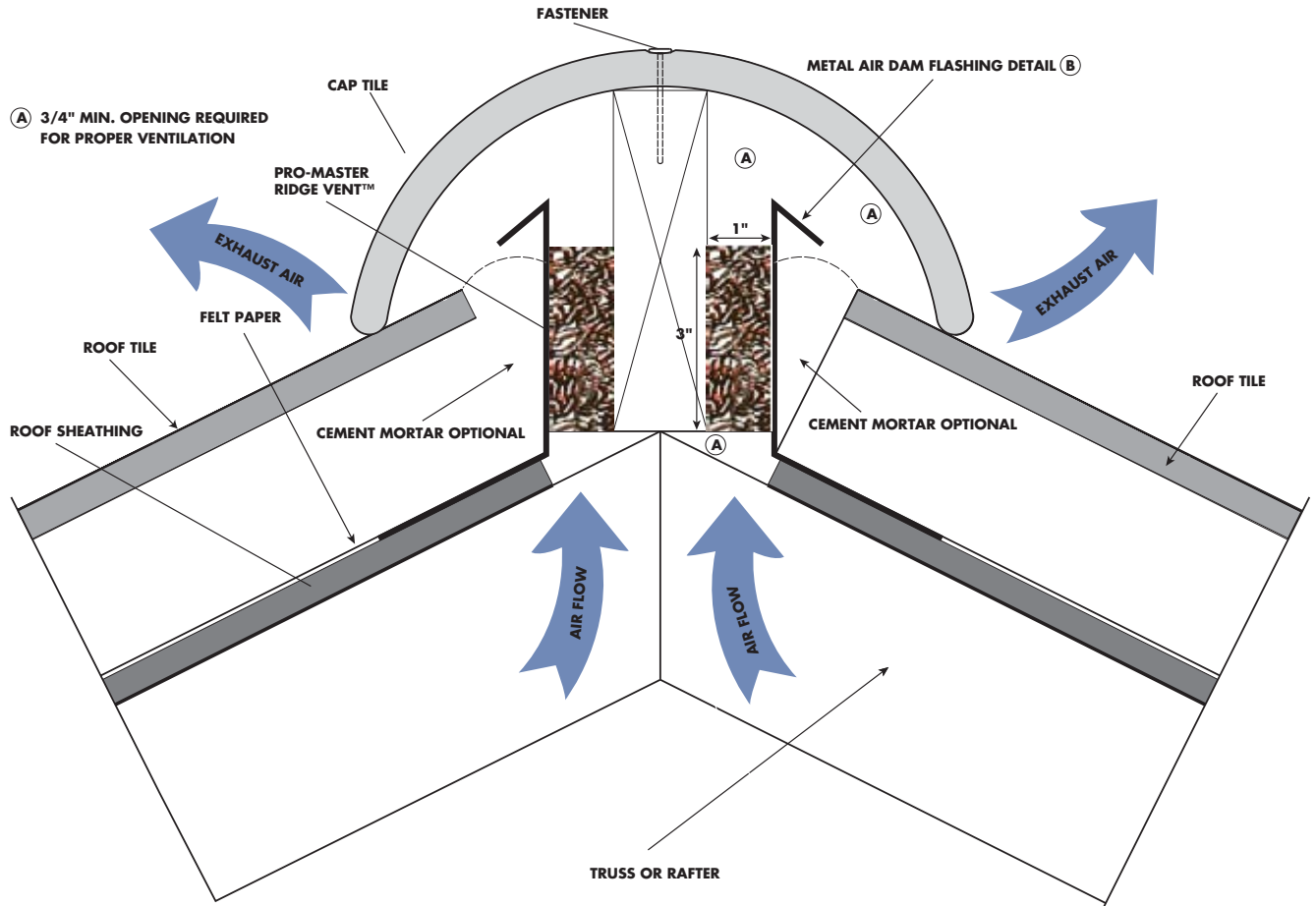

Pro-Master Ridge Vent™ Specifications:
10-1/2" wide x 3/4" thick x 50 ft. long

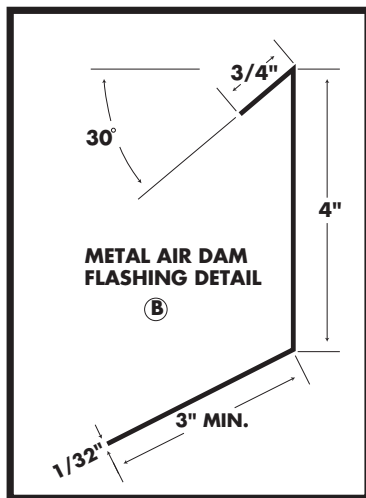

BERGER 805 PENNSYLVANIA BLVD. • FEASTERVILLE, PA 19053 • 800-523-8852		
DATE: 04-01-04	APPROVED BY: A. SWAN	DRAWN BY: SLHD
PRO-MASTER RIDGE VENT™ TYPICAL APPLICATION: BARREL OR S-TILE ROOF		

PRO-MASTER RIDGE VENT™ TYPICAL APPLICATION: STANDING SEAM METAL ROOFING & HIGH DOME CAP

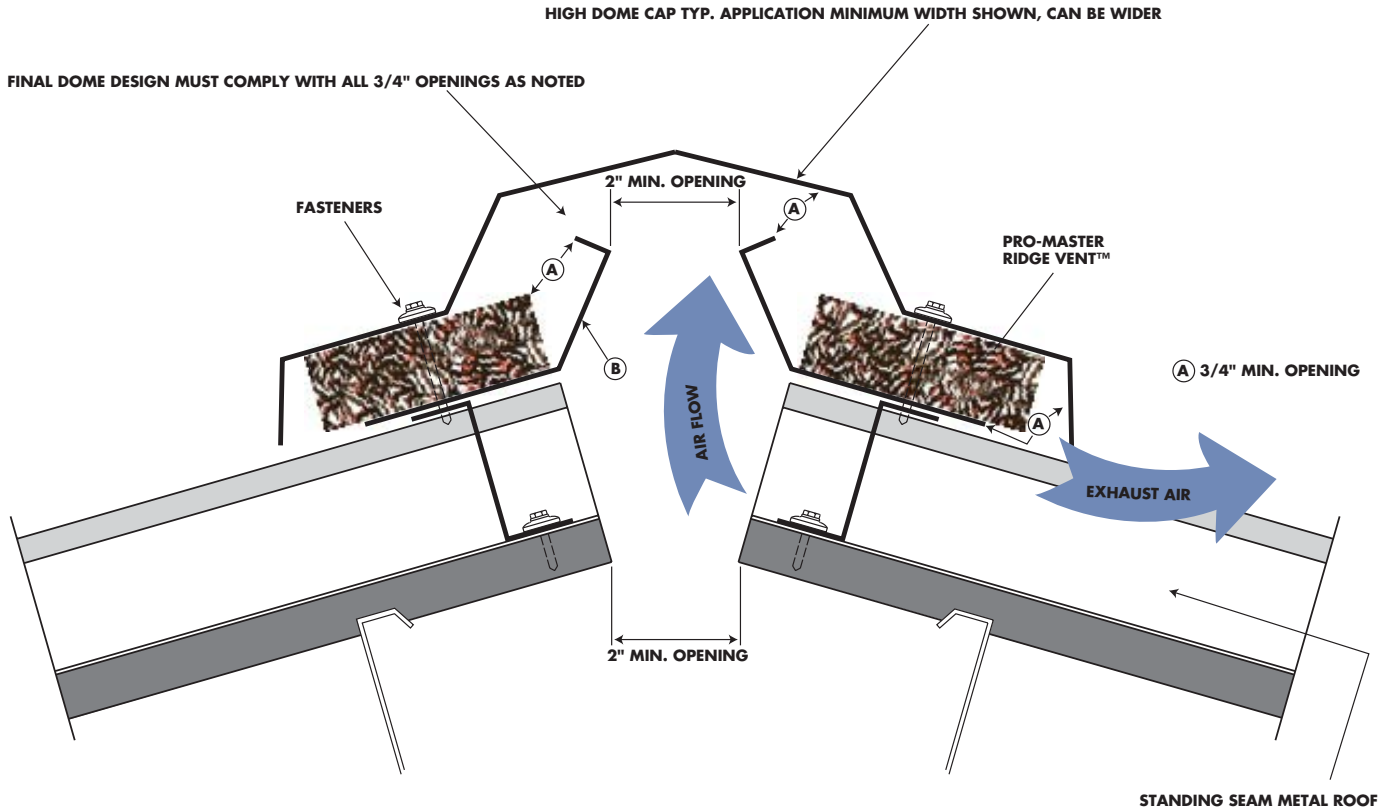

Pro-Master Ridge Vent™ Specifications:
10-1/2" wide x 3/4" thick x 50 ft. long

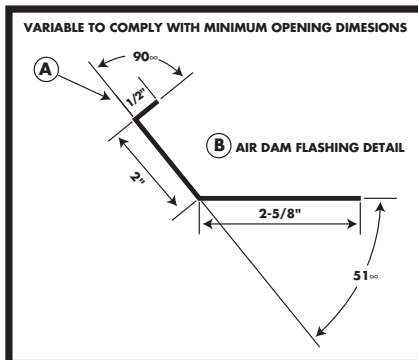

BERGER 805 PENNSYLVANIA BLVD. • FEASTERVILLE, PA 19053 • 800-523-8852		
DATE: 04-01-04	APPROVED BY: A. SWAN	DRAWN BY: SLHD
PRO-MASTER RIDGE VENT™ TYPICAL APPLICATION: STANDING SEAM METAL ROOFING & HIGH DOME CAP		

PRO-MASTER RIDGE VENT™ TYPICAL APPLICATION: STANDING SEAM METAL ROOF W/ LOW PROFILE RIDGE CAP

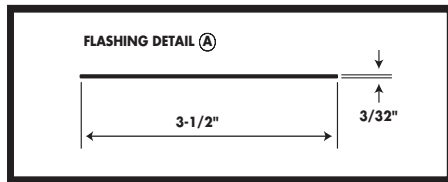
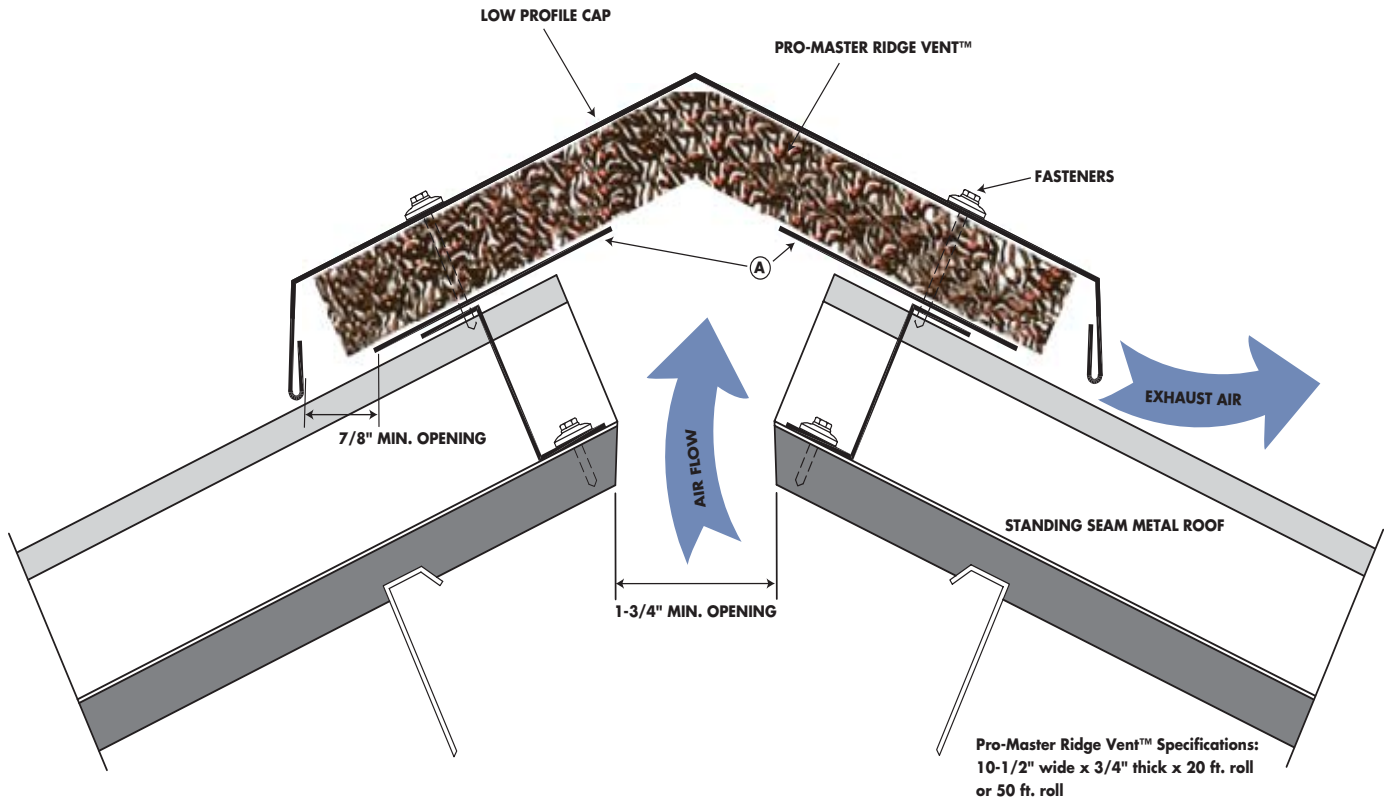

BERGER 805 PENNSYLVANIA BLVD. • FEASTERVILLE, PA 19053 • 800-523-8852		
DATE: 08-01-04	APPROVED BY: A. SWAN	DRAWN BY: SLHD
PRO-MASTER RIDGE VENT™ TYPICAL APPLICATION: STANDING SEAM METAL ROOF W/ LOW PROFILE RIDGE CAP		

PRO-MASTER RIDGE VENT™ TYPICAL APPLICATION: STANDING SEAM ROOF TO WALL

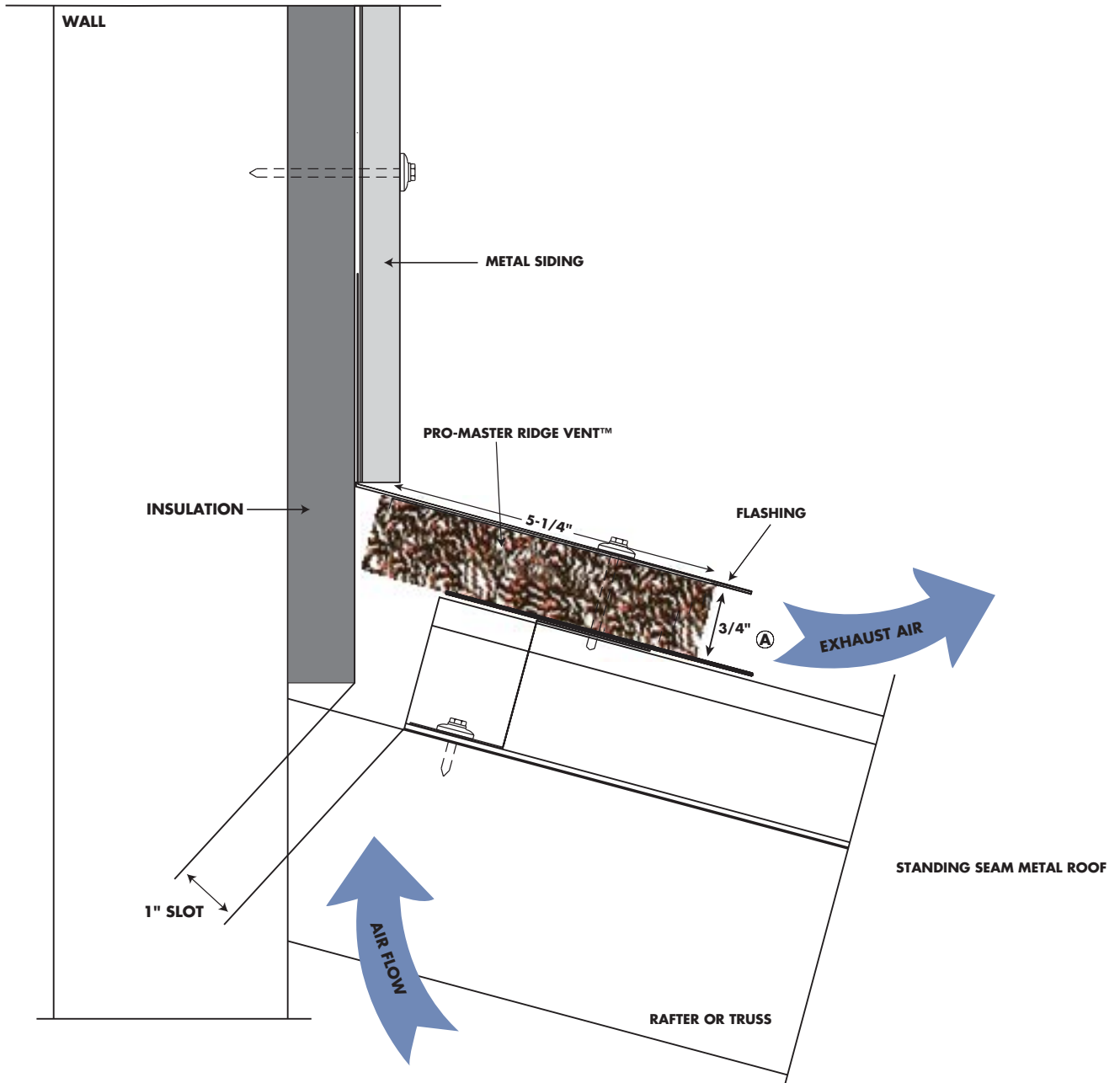

Pro-Master Ridge Vent™ Specifications:
10-1/2" wide x 3/4" thick x 20 ft. roll
or 50 ft. roll

Cut product in half to make 5-1/4" strip.

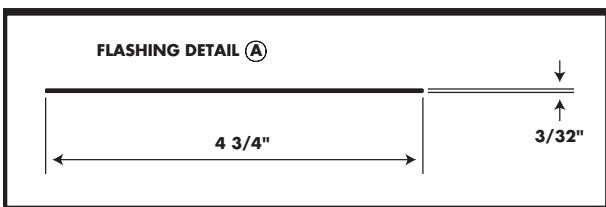

BERGER 805 PENNSYLVANIA BLVD. • FEASTERVILLE, PA 19053 • 800-523-8852		
DATE: 08-01-04	APPROVED BY: A. SWAN	DRAWN BY: SLHD
PRO-MASTER RIDGE VENT™ TYPICAL APPLICATION: STANDING SEAM ROOF TO WALL		

PRO-MASTER ROLLED RIDGE VENT NET FREE AREA CHART: 1:150 RATIO-NO MOISTURE BARRIER

1:150 ratio: Net Free Area Table-Use when no Moisture Barrier is installed.

The **MINIMUM** attic ventilation required by the Building Codes is 1 square foot of total net free area per 150 square feet of attic when no moisture barrier is used.

A **Balanced System** requires soffit ventilation in an amount equal to or greater than the amount of ridge ventilation. See soffit vent manufacturer's information on the Net Free Area provided by soffit vent product.

Attic Area (SF)	Total NFA (SF)	Ridge Ventilation NFA (SF)	Length of Ridge Vent (feet)	Soffit Ventilation NFA (SF)
1000	6.7	3.3	28.5	3.3
1100	7.3	3.7	31.3	3.7
1200	8.0	4.0	34.2	4.0
1300	8.7	4.3	37.0	4.3
1400	9.3	4.7	39.9	4.7
1500	10.0	5.0	42.7	5.0
1600	10.7	5.3	45.6	5.3
1700	11.3	5.7	48.4	5.7
1800	12.0	6.0	51.3	6.0
1900	12.7	6.3	54.1	6.3
2000	13.3	6.7	57.0	6.7
2100	14.0	7.0	59.8	7.0
2200	14.7	7.3	62.7	7.3
2300	15.3	7.7	65.5	7.7
2400	16.0	8.0	68.4	8.0
2500	16.7	8.3	71.2	8.3
2600	17.3	8.7	74.1	8.7
2700	18.0	9.0	76.9	9.0
2800	18.7	9.3	79.8	9.3
2900	19.3	9.7	82.6	9.7
3000	20.0	10.0	85.5	10.0
See soffit vent manufacturers instructions for NFA calculation.				

PRO-MASTER ROLLED RIDGE VENT NET FREE AREA CHART: 1:300 RATIO-WITH MOISTURE BARRIER

1:300 ratio: Net Free Area Table-Use when Moisture Barrier is installed

The **MINIMUM** attic ventilation required by the Building Codes is 1 square foot of total net free area per 300 square feet of attic when a moisture barrier is installed.

A **Balanced System** requires soffit ventilation in an amount equal to or greater than the amount of ridge ventilation. See soffit vent manufacturer's information on the Net Free Area provided by soffit vent product.

Attic Area (SF)	Total NFA (SF)	Ridge Ventilation NFA (SF)	Length of Ridge Vent (feet)	Soffit Ventilation NFA (SF)
1000	3.3	1.7	14.2	1.7
1100	3.7	1.8	15.7	1.8
1200	4.0	2.0	17.1	2.0
1300	4.3	2.2	18.5	2.2
1400	4.7	2.3	19.9	2.3
1500	5.0	2.5	21.4	2.5
1600	5.3	2.7	22.8	2.7
1700	5.7	2.8	24.2	2.8
1800	6.0	3.0	25.6	3.0
1900	6.3	3.2	27.1	3.2
2000	6.7	3.3	28.5	3.3
2100	7.0	3.5	29.9	3.5
2200	7.3	3.7	31.3	3.7
2300	7.7	3.8	32.8	3.8
2400	8.0	4.0	34.2	4.0
2500	8.3	4.2	35.6	4.2
2600	8.7	4.3	37.0	4.3
2700	9.0	4.5	38.5	4.5
2800	9.3	4.7	39.9	4.7
2900	9.7	4.8	41.3	4.8
3000	10.0	5.0	42.7	5.0
See soffit vent manufacturers instructions for NFA calculation.				